





| Assembly code  | Assembly description | Assembly image   |
|----------------|----------------------|--|
| ASM0305A/0.D05 | ASM0305A0            |   |
| ASM0308B/0.D04 | External cover       |   |
| ASM0313A/0.D01 | ASM0313A0            |  |

**ASM0305A/0.D05 - ASM0305A0**

**FRONT**

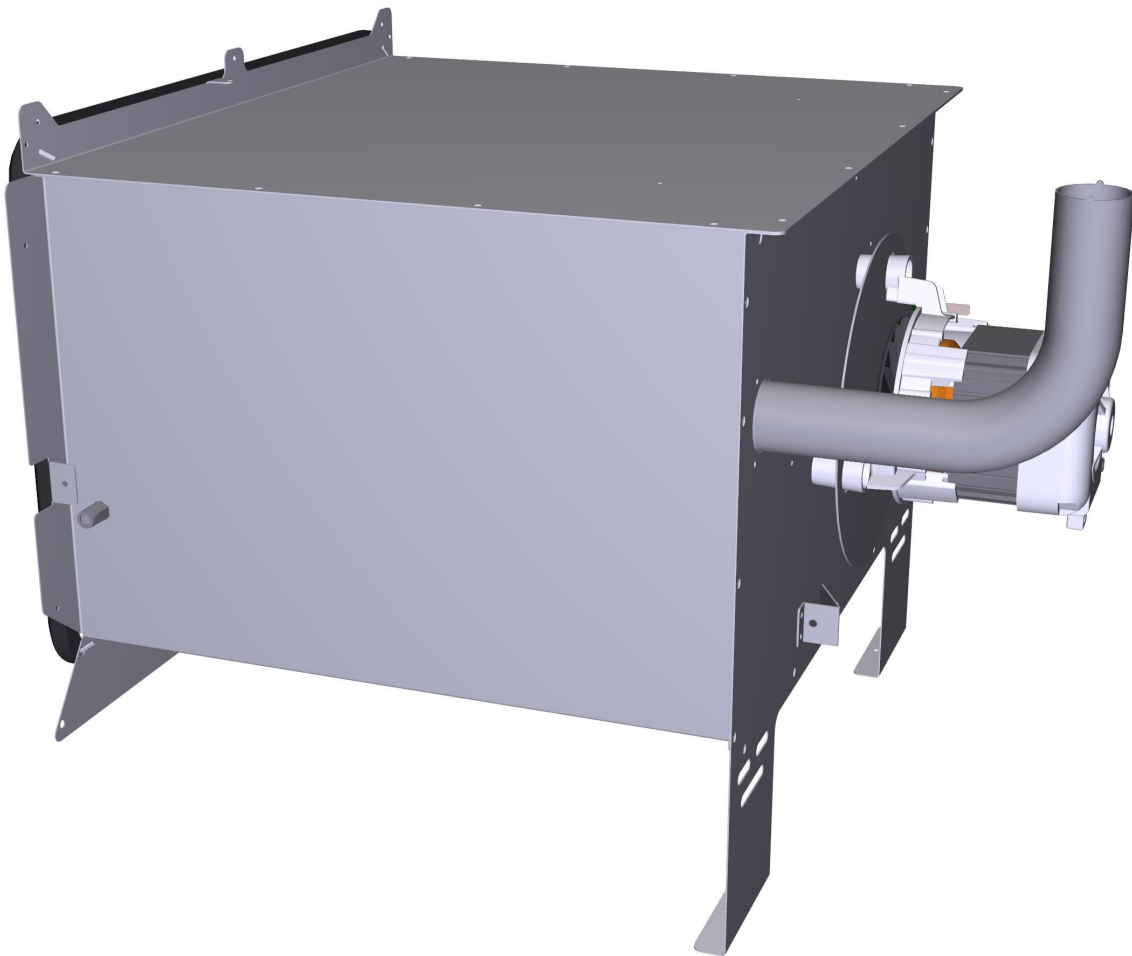





**ASM0305A/0.D05 - ASM0305A0**



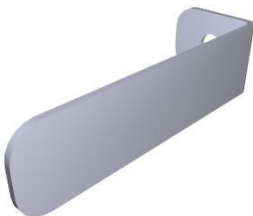

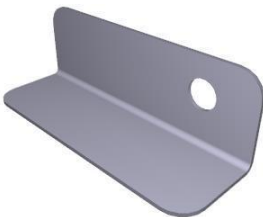
**REAR**





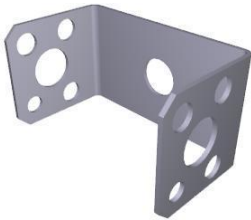



| COMPONENT |   |   | SPARE PART |   |                |
|-----------|---|---|------------|---|----------------|
| Code      | Description                                 | Image   | Code       | Description                                 | Kit components |
| 0G1210A   | L.MICRO ROBERTA<br>ST. STEEL FAN<br>GUARD   |    | 0G1210A0   | L.MICRO ROBERTA<br>ST. STEEL FAN<br>GUARD   |                |
| 0G1231A   | XF023 TAINLESS<br>STEEL FAN GUARD<br>SPACER |    | 0G1231A0   | XF023 TAINLESS<br>STEEL FAN GUARD<br>SPACER |                |
| 0H3020A   | MOTOR SHAFT<br>SEALING DISC                 |  | 0H3020A1   | MOTOR SHAFT<br>SEALING DISC                 |                |
| 0H3330B   | L.MCR REINFORC<br>BAR FOR INT. BACK<br>WALL |  | 0H3330B0   | L.MCR REINFORC<br>BAR FOR INT. BACK<br>WALL |                |
| 0H3590A   | SAFETY<br>THERMOSTAT BULB<br>FASTENER       |  | 0H3590A1   | SAFETY<br>THERMOSTAT BULB<br>FASTENER       |                |



| COMPONENT |  |   | SPARE PART |  |  |      |             |     |     |          |                        |        |    |          |                 |       |    |          |                                   |       |    |          |  |       |    |          |                       |       |    |
|-----------|--|---|------------|--|--|------|-------------|-----|-----|----------|------------------------|--------|----|----------|-----------------|-------|----|----------|-----------------------------------|-------|----|----------|--|-------|----|----------|-----------------------|-------|----|
| Code      | Description                            | Image   | Code       | Description                            | Kit components   |      |             |     |     |          |                        |        |    |          |                 |       |    |          |                                   |       |    |          |  |       |    |          |                       |       |    |
| 0H4820A   | BULB HOLDING BRACKET                   |    | 0H4820A1   | BULB HOLDING BRACKET                   |  |      |             |     |     |          |                        |        |    |          |                 |       |    |          |                                   |       |    |          |  |       |    |          |                       |       |    |
| AGRP205   | WIRE GRID 342x242 FLAT CHROMIUM PLATED |    | AGRP2050   | WIRE GRID 342x242 FLAT CHROMIUM PLATED |  |      |             |     |     |          |                        |        |    |          |                 |       |    |          |                                   |       |    |          |  |       |    |          |                       |       |    |
| 0H3585A   | ZINCED MOTOR GUARD PLATE L.M.          |  | 0H3585A0   | ZINCED MOTOR GUARD PLATE L.M.          |  |      |             |     |     |          |                        |        |    |          |                 |       |    |          |                                   |       |    |          |  |       |    |          |                       |       |    |
| VI1785A   | CHROMIUM PLATED BRASS SCREW M6x12      |  | KVI1785A   | M6x12 SCREW 20 PCS. KIT                | <table border="1"> <thead> <tr> <th>Code</th> <th>Description</th> <th>Qty</th> <th>UOM</th> </tr> </thead> <tbody> <tr> <td>VI1300A0</td> <td>SCREW M6X12 T1/2T+INOX</td> <td>20.000</td> <td>PC</td> </tr> </tbody> </table>   | Code | Description | Qty | UOM | VI1300A0 | SCREW M6X12 T1/2T+INOX | 20.000 | PC |          |                 |       |    |          |                                   |       |    |          |  |       |    |          |                       |       |    |
| Code      | Description                            | Qty   | UOM        |  |  |      |             |     |     |          |                        |        |    |          |                 |       |    |          |                                   |       |    |          |  |       |    |          |                       |       |    |
| VI1300A0  | SCREW M6X12 T1/2T+INOX                 | 20.000  | PC         |  |  |      |             |     |     |          |                        |        |    |          |                 |       |    |          |                                   |       |    |          |  |       |    |          |                       |       |    |
| VN1045C   | Line Miss 120 VAC MOTOR                |  | KVN1045C   | MOTOR KIT 120V                         | <table border="1"> <thead> <tr> <th>Code</th> <th>Description</th> <th>Qty</th> <th>UOM</th> </tr> </thead> <tbody> <tr> <td>GN1270A0</td> <td>13x5.5x0.8 FLAT WASHER</td> <td>3.000</td> <td>PC</td> </tr> <tr> <td>GN1546A0</td> <td>SHAFT GASKET D8</td> <td>1.000</td> <td>PC</td> </tr> <tr> <td>VI1695A0</td> <td>M6x16 H6 CH10 STAINLESS STEEL NUT</td> <td>1.000</td> <td>PC</td> </tr> <tr> <td>VI1700A0</td> <td>18x6.4x1.5 STAINLESS STEEL FLAT WASHER</td> <td>1.000</td> <td>PC</td> </tr> <tr> <td>VI1836A0</td> <td>M6x12 OT63 ROTOR SCRE</td> <td>3.000</td> <td>PC</td> </tr> </tbody> </table> | Code | Description | Qty | UOM | GN1270A0 | 13x5.5x0.8 FLAT WASHER | 3.000  | PC | GN1546A0 | SHAFT GASKET D8 | 1.000 | PC | VI1695A0 | M6x16 H6 CH10 STAINLESS STEEL NUT | 1.000 | PC | VI1700A0 | 18x6.4x1.5 STAINLESS STEEL FLAT WASHER | 1.000 | PC | VI1836A0 | M6x12 OT63 ROTOR SCRE | 3.000 | PC |
| Code      | Description                            | Qty   | UOM        |  |  |      |             |     |     |          |                        |        |    |          |                 |       |    |          |                                   |       |    |          |  |       |    |          |                       |       |    |
| GN1270A0  | 13x5.5x0.8 FLAT WASHER                 | 3.000   | PC         |  |  |      |             |     |     |          |                        |        |    |          |                 |       |    |          |                                   |       |    |          |  |       |    |          |                       |       |    |
| GN1546A0  | SHAFT GASKET D8                        | 1.000   | PC         |  |  |      |             |     |     |          |                        |        |    |          |                 |       |    |          |                                   |       |    |          |  |       |    |          |                       |       |    |
| VI1695A0  | M6x16 H6 CH10 STAINLESS STEEL NUT      | 1.000   | PC         |  |  |      |             |     |     |          |                        |        |    |          |                 |       |    |          |                                   |       |    |          |  |       |    |          |                       |       |    |
| VI1700A0  | 18x6.4x1.5 STAINLESS STEEL FLAT WASHER | 1.000   | PC         |  |  |      |             |     |     |          |                        |        |    |          |                 |       |    |          |                                   |       |    |          |  |       |    |          |                       |       |    |
| VI1836A0  | M6x12 OT63 ROTOR SCRE                  | 3.000   | PC         |  |  |      |             |     |     |          |                        |        |    |          |                 |       |    |          |                                   |       |    |          |  |       |    |          |                       |       |    |

| COMPONENT |   |   | SPARE PART |                                       |  |      |             |     |     |          |  |       |    |          |   |       |    |          |  |       |    |          |                                      |       |    |
|-----------|---|---|------------|---------------------------------------|--|------|-------------|-----|-----|----------|--|-------|----|----------|---|-------|----|----------|--|-------|----|----------|--------------------------------------|-------|----|
| Code      | Description   | Image   | Code       | Description                           | Kit components   |      |             |     |     |          |  |       |    |          |   |       |    |          |  |       |    |          |                                      |       |    |
| VN1045C   | Line Miss 120 VAC MOTOR                             |    | KVN1045C   | MOTOR KIT 120V                        | <table border="1"> <thead> <tr> <th>Code</th> <th>Description</th> <th>Qty</th> <th>UOM</th> </tr> </thead> <tbody> <tr> <td>VM1794A0</td> <td>250x4.8 PA66<br/>BLACK CLAMP</td> <td>3.000</td> <td>PC</td> </tr> <tr> <td>VM2103A0</td> <td>CLAMP LOCK</td> <td>3.000</td> <td>PC</td> </tr> <tr> <td>VN1045C1</td> <td>Line Miss 120<br/>VAC MOTOR</td> <td>1.000</td> <td>PC</td> </tr> </tbody> </table>   | Code | Description | Qty | UOM | VM1794A0 | 250x4.8 PA66<br>BLACK CLAMP                | 3.000 | PC | VM2103A0 | CLAMP LOCK  | 3.000 | PC | VN1045C1 | Line Miss 120<br>VAC MOTOR                       | 1.000 | PC |          |                                      |       |    |
| Code      | Description   | Qty   | UOM        |                                       |  |      |             |     |     |          |  |       |    |          |   |       |    |          |  |       |    |          |                                      |       |    |
| VM1794A0  | 250x4.8 PA66<br>BLACK CLAMP                         | 3.000   | PC         |                                       |  |      |             |     |     |          |  |       |    |          |   |       |    |          |  |       |    |          |                                      |       |    |
| VM2103A0  | CLAMP LOCK  | 3.000   | PC         |                                       |  |      |             |     |     |          |  |       |    |          |   |       |    |          |  |       |    |          |                                      |       |    |
| VN1045C1  | Line Miss 120<br>VAC MOTOR                          | 1.000   | PC         |                                       |  |      |             |     |     |          |  |       |    |          |   |       |    |          |  |       |    |          |                                      |       |    |
| VN1110A   | Ø162 H=32 32<br>BLADES STAINLESS<br>STEEL FAN       |    | KVN1110A   | D162 H32 FAN KIT                      | <table border="1"> <thead> <tr> <th>Code</th> <th>Description</th> <th>Qty</th> <th>UOM</th> </tr> </thead> <tbody> <tr> <td>VI1695A0</td> <td>M6x16 H6<br/>CH10<br/>STAINLESS<br/>STEEL NUT</td> <td>1.000</td> <td>PC</td> </tr> <tr> <td>VI1700A0</td> <td>18x6.4x1.5<br/>STAINLESS<br/>STEEL FLAT<br/>WASHER</td> <td>1.000</td> <td>PC</td> </tr> <tr> <td>VN1110A0</td> <td>Ø162 H=32 32<br/>BLADES<br/>STAINLESS<br/>STEEL FAN</td> <td>1.000</td> <td>PC</td> </tr> </tbody> </table>  | Code | Description | Qty | UOM | VI1695A0 | M6x16 H6<br>CH10<br>STAINLESS<br>STEEL NUT | 1.000 | PC | VI1700A0 | 18x6.4x1.5<br>STAINLESS<br>STEEL FLAT<br>WASHER     | 1.000 | PC | VN1110A0 | Ø162 H=32 32<br>BLADES<br>STAINLESS<br>STEEL FAN | 1.000 | PC |          |                                      |       |    |
| Code      | Description   | Qty   | UOM        |                                       |  |      |             |     |     |          |  |       |    |          |   |       |    |          |  |       |    |          |                                      |       |    |
| VI1695A0  | M6x16 H6<br>CH10<br>STAINLESS<br>STEEL NUT          | 1.000   | PC         |                                       |  |      |             |     |     |          |  |       |    |          |   |       |    |          |  |       |    |          |                                      |       |    |
| VI1700A0  | 18x6.4x1.5<br>STAINLESS<br>STEEL FLAT<br>WASHER     | 1.000   | PC         |                                       |  |      |             |     |     |          |  |       |    |          |   |       |    |          |  |       |    |          |                                      |       |    |
| VN1110A0  | Ø162 H=32 32<br>BLADES<br>STAINLESS<br>STEEL FAN    | 1.000   | PC         |                                       |  |      |             |     |     |          |  |       |    |          |   |       |    |          |  |       |    |          |                                      |       |    |
| GN1326A   | ELEMENT SEALING                                     |  | KRS1274A   | 100W MOTOR<br>BRAKING ELEMENT<br>KIT  | <table border="1"> <thead> <tr> <th>Code</th> <th>Description</th> <th>Qty</th> <th>UOM</th> </tr> </thead> <tbody> <tr> <td>GN1672A1</td> <td>BREAKING<br/>ELEMENT<br/>GASKET</td> <td>1.000</td> <td>PC</td> </tr> <tr> <td>RS1274A0</td> <td>100W 60V 1<br/>TURN FLAT<br/>ELEMENT</td> <td>1.000</td> <td>PC</td> </tr> <tr> <td>SL1045A0</td> <td>S57 BLACK<br/>SILICONE -<br/>80ml<br/>CARTRIDGE</td> <td>1.000</td> <td>PC</td> </tr> <tr> <td>VI1220A1</td> <td>4,2x12 TCB<br/>SELF-TAPPIN<br/>G SCREW</td> <td>2.000</td> <td>PC</td> </tr> </tbody> </table>        | Code | Description | Qty | UOM | GN1672A1 | BREAKING<br>ELEMENT<br>GASKET              | 1.000 | PC | RS1274A0 | 100W 60V 1<br>TURN FLAT<br>ELEMENT                  | 1.000 | PC | SL1045A0 | S57 BLACK<br>SILICONE -<br>80ml<br>CARTRIDGE     | 1.000 | PC | VI1220A1 | 4,2x12 TCB<br>SELF-TAPPIN<br>G SCREW | 2.000 | PC |
| Code      | Description   | Qty   | UOM        |                                       |  |      |             |     |     |          |  |       |    |          |   |       |    |          |  |       |    |          |                                      |       |    |
| GN1672A1  | BREAKING<br>ELEMENT<br>GASKET                       | 1.000   | PC         |                                       |  |      |             |     |     |          |  |       |    |          |   |       |    |          |  |       |    |          |                                      |       |    |
| RS1274A0  | 100W 60V 1<br>TURN FLAT<br>ELEMENT                  | 1.000   | PC         |                                       |  |      |             |     |     |          |  |       |    |          |   |       |    |          |  |       |    |          |                                      |       |    |
| SL1045A0  | S57 BLACK<br>SILICONE -<br>80ml<br>CARTRIDGE        | 1.000   | PC         |                                       |  |      |             |     |     |          |  |       |    |          |   |       |    |          |  |       |    |          |                                      |       |    |
| VI1220A1  | 4,2x12 TCB<br>SELF-TAPPIN<br>G SCREW                | 2.000   | PC         |                                       |  |      |             |     |     |          |  |       |    |          |   |       |    |          |  |       |    |          |                                      |       |    |
| GN1326A   | ELEMENT SEALING                                     |  | KRS1261A   | 122W MOTOR<br>BREAKING<br>ELEMENT KIT | <table border="1"> <thead> <tr> <th>Code</th> <th>Description</th> <th>Qty</th> <th>UOM</th> </tr> </thead> <tbody> <tr> <td>GN1326A1</td> <td>ELEMENT<br/>SEALING</td> <td>1.000</td> <td>PC</td> </tr> <tr> <td>RS1261A0</td> <td>BAKERLUXCH<br/>EFLUX<br/>MOTOR<br/>BREAKING<br/>ELEMENT</td> <td>1.000</td> <td>PC</td> </tr> <tr> <td>SL1045A0</td> <td>S57 BLACK<br/>SILICONE -<br/>80ml<br/>CARTRIDGE</td> <td>1.000</td> <td>PC</td> </tr> <tr> <td>VI1220A1</td> <td>4,2x12 TCB<br/>SELF-TAPPIN<br/>G SCREW</td> <td>2.000</td> <td>PC</td> </tr> </tbody> </table> | Code | Description | Qty | UOM | GN1326A1 | ELEMENT<br>SEALING                         | 1.000 | PC | RS1261A0 | BAKERLUXCH<br>EFLUX<br>MOTOR<br>BREAKING<br>ELEMENT | 1.000 | PC | SL1045A0 | S57 BLACK<br>SILICONE -<br>80ml<br>CARTRIDGE     | 1.000 | PC | VI1220A1 | 4,2x12 TCB<br>SELF-TAPPIN<br>G SCREW | 2.000 | PC |
| Code      | Description   | Qty   | UOM        |                                       |  |      |             |     |     |          |  |       |    |          |   |       |    |          |  |       |    |          |                                      |       |    |
| GN1326A1  | ELEMENT<br>SEALING                                  | 1.000   | PC         |                                       |  |      |             |     |     |          |  |       |    |          |   |       |    |          |  |       |    |          |                                      |       |    |
| RS1261A0  | BAKERLUXCH<br>EFLUX<br>MOTOR<br>BREAKING<br>ELEMENT | 1.000   | PC         |                                       |  |      |             |     |     |          |  |       |    |          |   |       |    |          |  |       |    |          |                                      |       |    |
| SL1045A0  | S57 BLACK<br>SILICONE -<br>80ml<br>CARTRIDGE        | 1.000   | PC         |                                       |  |      |             |     |     |          |  |       |    |          |   |       |    |          |  |       |    |          |                                      |       |    |
| VI1220A1  | 4,2x12 TCB<br>SELF-TAPPIN<br>G SCREW                | 2.000   | PC         |                                       |  |      |             |     |     |          |  |       |    |          |   |       |    |          |  |       |    |          |                                      |       |    |







| COMPONENT |  |   | SPARE PART |  |  |      |             |                    |       |          |                               |   |       |          |                                  |  |       |          |  |                             |       |          |                                      |            |       |    |
|-----------|--|---|------------|--|--|------|-------------|--------------------|-------|----------|-------------------------------|---|-------|----------|----------------------------------|--|-------|----------|--|-----------------------------|-------|----------|--------------------------------------|------------|-------|----|
| Code      | Description                                  | Image   | Code       | Description                                  | Kit components   |      |             |                    |       |          |                               |   |       |          |                                  |  |       |          |  |                             |       |          |                                      |            |       |    |
| GN1326A   | ELEMENT SEALING                              |    | KRS1215A   | 147W MOTOR<br>BRAKING ELEMENT<br>KIT         | <table border="1"> <thead> <tr> <th>Code</th> <th>Description</th> <th>Qty</th> <th>UOM</th> </tr> </thead> <tbody> <tr> <td>GN1672A1</td> <td>BREAKING<br/>ELEMENT<br/>GASKET</td> <td>1.000</td> <td>PC</td> </tr> <tr> <td>RS1215A1</td> <td>147W 105V<br/>BRAKING<br/>ELEMENT</td> <td>1.000</td> <td>PC</td> </tr> <tr> <td>SL1045A0</td> <td>S57 BLACK<br/>SILICONE -<br/>80ml<br/>CARTRIDGE</td> <td>1.000</td> <td>PC</td> </tr> <tr> <td>VI1220A1</td> <td>4,2x12 TCB<br/>SELF-TAPPIN<br/>G SCREW</td> <td>2.000</td> <td>PC</td> </tr> </tbody> </table> | Code | Description | Qty                | UOM   | GN1672A1 | BREAKING<br>ELEMENT<br>GASKET | 1.000                                   | PC    | RS1215A1 | 147W 105V<br>BRAKING<br>ELEMENT  | 1.000  | PC    | SL1045A0 | S57 BLACK<br>SILICONE -<br>80ml<br>CARTRIDGE | 1.000                       | PC    | VI1220A1 | 4,2x12 TCB<br>SELF-TAPPIN<br>G SCREW | 2.000      | PC    |    |
|           |  |   | Code       | Description                                  | Qty  | UOM  |             |                    |       |          |                               |   |       |          |                                  |  |       |          |  |                             |       |          |                                      |            |       |    |
|           |  |   | GN1672A1   | BREAKING<br>ELEMENT<br>GASKET                | 1.000  | PC   |             |                    |       |          |                               |   |       |          |                                  |  |       |          |  |                             |       |          |                                      |            |       |    |
|           |  |   | RS1215A1   | 147W 105V<br>BRAKING<br>ELEMENT              | 1.000  | PC   |             |                    |       |          |                               |   |       |          |                                  |  |       |          |  |                             |       |          |                                      |            |       |    |
|           |  |   | SL1045A0   | S57 BLACK<br>SILICONE -<br>80ml<br>CARTRIDGE | 1.000  | PC   |             |                    |       |          |                               |   |       |          |                                  |  |       |          |  |                             |       |          |                                      |            |       |    |
|           |  |   | VI1220A1   | 4,2x12 TCB<br>SELF-TAPPIN<br>G SCREW         | 2.000  | PC   |             |                    |       |          |                               |   |       |          |                                  |  |       |          |  |                             |       |          |                                      |            |       |    |
|           |  |   | KRS1095A   | 1.2kW HEATING<br>ELEMENT KIT                 | <table border="1"> <thead> <tr> <th>Code</th> <th>Description</th> <th>Qty</th> <th>UOM</th> </tr> </thead> <tbody> <tr> <td>GN1326A1</td> <td>ELEMENT<br/>SEALING</td> <td>1.000</td> <td>PC</td> </tr> <tr> <td>RS1095A1</td> <td>HEATING<br/>ELEMENT<br/>1200W 230V</td> <td>1.000</td> <td>PC</td> </tr> <tr> <td>SL1045A0</td> <td>S57 BLACK<br/>SILICONE -<br/>80ml<br/>CARTRIDGE</td> <td>1.000</td> <td>PC</td> </tr> <tr> <td>VI1220A1</td> <td>4,2x12 TCB<br/>SELF-TAPPIN<br/>G SCREW</td> <td>2.000</td> <td>PC</td> </tr> </tbody> </table>            | Code | Description | Qty                | UOM   | GN1326A1 | ELEMENT<br>SEALING            | 1.000                                   | PC    | RS1095A1 | HEATING<br>ELEMENT<br>1200W 230V | 1.000  | PC    | SL1045A0 | S57 BLACK<br>SILICONE -<br>80ml<br>CARTRIDGE | 1.000                       | PC    | VI1220A1 | 4,2x12 TCB<br>SELF-TAPPIN<br>G SCREW | 2.000      | PC    |    |
|           |  |   | Code       | Description                                  | Qty  | UOM  |             |                    |       |          |                               |   |       |          |                                  |  |       |          |  |                             |       |          |                                      |            |       |    |
|           |  |   | GN1326A1   | ELEMENT<br>SEALING                           | 1.000  | PC   |             |                    |       |          |                               |   |       |          |                                  |  |       |          |  |                             |       |          |                                      |            |       |    |
|           |  |   | RS1095A1   | HEATING<br>ELEMENT<br>1200W 230V             | 1.000  | PC   |             |                    |       |          |                               |   |       |          |                                  |  |       |          |  |                             |       |          |                                      |            |       |    |
|           |  |   | SL1045A0   | S57 BLACK<br>SILICONE -<br>80ml<br>CARTRIDGE | 1.000  | PC   |             |                    |       |          |                               |   |       |          |                                  |  |       |          |  |                             |       |          |                                      |            |       |    |
|           |  |   | VI1220A1   | 4,2x12 TCB<br>SELF-TAPPIN<br>G SCREW         | 2.000  | PC   |             |                    |       |          |                               |   |       |          |                                  |  |       |          |  |                             |       |          |                                      |            |       |    |
| KRS1012A  | 1365W 120V<br>HEATING ELEMENT<br>KIT         | <table border="1"> <thead> <tr> <th>Code</th> <th>Description</th> <th>Qty</th> <th>UOM</th> </tr> </thead> <tbody> <tr> <td>GN1326A1</td> <td>ELEMENT<br/>SEALING</td> <td>1.000</td> <td>PC</td> </tr> <tr> <td>RS1012A0</td> <td>CIRCULAR<br/>ELEMENT<br/>1365W 120V</td> <td>1.000</td> <td>PC</td> </tr> <tr> <td>VI1220A1</td> <td>4,2x12 TCB<br/>SELF-TAPPIN<br/>G SCREW</td> <td>5.000</td> <td>PC</td> </tr> <tr> <td>VM1794A0</td> <td>250x4.8 PA66<br/>BLACK CLAMP</td> <td>2.000</td> <td>PC</td> </tr> <tr> <td>VM2103A0</td> <td>CLAMP LOCK</td> <td>2.000</td> <td>PC</td> </tr> </tbody> </table> | Code       | Description                                  | Qty  | UOM  | GN1326A1    | ELEMENT<br>SEALING | 1.000 | PC       | RS1012A0                      | CIRCULAR<br>ELEMENT<br>1365W 120V       | 1.000 | PC       | VI1220A1                         | 4,2x12 TCB<br>SELF-TAPPIN<br>G SCREW         | 5.000 | PC       | VM1794A0                                     | 250x4.8 PA66<br>BLACK CLAMP | 2.000 | PC       | VM2103A0                             | CLAMP LOCK | 2.000 | PC |
| Code      | Description                                  | Qty   | UOM        |  |  |      |             |                    |       |          |                               |   |       |          |                                  |  |       |          |  |                             |       |          |                                      |            |       |    |
| GN1326A1  | ELEMENT<br>SEALING                           | 1.000   | PC         |  |  |      |             |                    |       |          |                               |   |       |          |                                  |  |       |          |  |                             |       |          |                                      |            |       |    |
| RS1012A0  | CIRCULAR<br>ELEMENT<br>1365W 120V            | 1.000   | PC         |  |  |      |             |                    |       |          |                               |   |       |          |                                  |  |       |          |  |                             |       |          |                                      |            |       |    |
| VI1220A1  | 4,2x12 TCB<br>SELF-TAPPIN<br>G SCREW         | 5.000   | PC         |  |  |      |             |                    |       |          |                               |   |       |          |                                  |  |       |          |  |                             |       |          |                                      |            |       |    |
| VM1794A0  | 250x4.8 PA66<br>BLACK CLAMP                  | 2.000   | PC         |  |  |      |             |                    |       |          |                               |   |       |          |                                  |  |       |          |  |                             |       |          |                                      |            |       |    |
| VM2103A0  | CLAMP LOCK                                   | 2.000   | PC         |  |  |      |             |                    |       |          |                               |   |       |          |                                  |  |       |          |  |                             |       |          |                                      |            |       |    |
| KRS1011A  | ROBERTA/LISA<br>HEATING ELEMENT<br>KIT       | <table border="1"> <thead> <tr> <th>Code</th> <th>Description</th> <th>Qty</th> <th>UOM</th> </tr> </thead> <tbody> <tr> <td>GN1326A1</td> <td>ELEMENT<br/>SEALING</td> <td>1.000</td> <td>PC</td> </tr> <tr> <td>RS1011A0</td> <td>2560W<br/>220-230V<br/>HEATING<br/>ELEMENT</td> <td>1.000</td> <td>PC</td> </tr> <tr> <td>SL1045A0</td> <td>S57 BLACK<br/>SILICONE -<br/>80ml<br/>CARTRIDGE</td> <td>1.000</td> <td>PC</td> </tr> </tbody> </table>   | Code       | Description                                  | Qty  | UOM  | GN1326A1    | ELEMENT<br>SEALING | 1.000 | PC       | RS1011A0                      | 2560W<br>220-230V<br>HEATING<br>ELEMENT | 1.000 | PC       | SL1045A0                         | S57 BLACK<br>SILICONE -<br>80ml<br>CARTRIDGE | 1.000 | PC       |  |                             |       |          |                                      |            |       |    |
| Code      | Description                                  | Qty   | UOM        |  |  |      |             |                    |       |          |                               |   |       |          |                                  |  |       |          |  |                             |       |          |                                      |            |       |    |
| GN1326A1  | ELEMENT<br>SEALING                           | 1.000   | PC         |  |  |      |             |                    |       |          |                               |   |       |          |                                  |  |       |          |  |                             |       |          |                                      |            |       |    |
| RS1011A0  | 2560W<br>220-230V<br>HEATING<br>ELEMENT      | 1.000   | PC         |  |  |      |             |                    |       |          |                               |   |       |          |                                  |  |       |          |  |                             |       |          |                                      |            |       |    |
| SL1045A0  | S57 BLACK<br>SILICONE -<br>80ml<br>CARTRIDGE | 1.000   | PC         |  |  |      |             |                    |       |          |                               |   |       |          |                                  |  |       |          |  |                             |       |          |                                      |            |       |    |





| COMPONENT |   |  | SPARE PART         |   |   |                                      |             |                    |       |          |                                      |   |       |          |   |                                      |       |          |                                      |                             |       |          |                             |            |       |          |            |       |    |
|-----------|---|--|--------------------|---|---|--------------------------------------|-------------|--------------------|-------|----------|--------------------------------------|---|-------|----------|---|--------------------------------------|-------|----------|--------------------------------------|-----------------------------|-------|----------|-----------------------------|------------|-------|----------|------------|-------|----|
| Code      | Description                                   | Image  | Code               | Description                             | Kit components  |                                      |             |                    |       |          |                                      |   |       |          |   |                                      |       |          |                                      |                             |       |          |                             |            |       |          |            |       |    |
| GN1326A   | ELEMENT SEALING                               |   | KRS1011A           | ROBERTA/LISA<br>HEATING ELEMENT<br>KIT  | <table border="1"> <thead> <tr> <th>Code</th> <th>Description</th> <th>Qty</th> <th>UOM</th> </tr> </thead> <tbody> <tr> <td>VI1220A1</td> <td>4,2x12 TCB<br/>SELF-TAPPIN<br/>G SCREW</td> <td>5.000</td> <td>PC</td> </tr> <tr> <td>VM1794A0</td> <td>250x4.8 PA66<br/>BLACK CLAMP</td> <td>2.000</td> <td>PC</td> </tr> <tr> <td>VM2103A0</td> <td>CLAMP LOCK</td> <td>2.000</td> <td>PC</td> </tr> </tbody> </table>   | Code                                 | Description | Qty                | UOM   | VI1220A1 | 4,2x12 TCB<br>SELF-TAPPIN<br>G SCREW | 5.000   | PC    | VM1794A0 | 250x4.8 PA66<br>BLACK CLAMP             | 2.000                                | PC    | VM2103A0 | CLAMP LOCK                           | 2.000                       | PC    |          |                             |            |       |          |            |       |    |
|           |   |  |                    |   | Code  | Description                          | Qty         | UOM                |       |          |                                      |   |       |          |   |                                      |       |          |                                      |                             |       |          |                             |            |       |          |            |       |    |
|           |   |  |                    |   | VI1220A1  | 4,2x12 TCB<br>SELF-TAPPIN<br>G SCREW | 5.000       | PC                 |       |          |                                      |   |       |          |   |                                      |       |          |                                      |                             |       |          |                             |            |       |          |            |       |    |
|           |   |  | VM1794A0           | 250x4.8 PA66<br>BLACK CLAMP             | 2.000   | PC                                   |             |                    |       |          |                                      |   |       |          |   |                                      |       |          |                                      |                             |       |          |                             |            |       |          |            |       |    |
|           |   |  | VM2103A0           | CLAMP LOCK                              | 2.000   | PC                                   |             |                    |       |          |                                      |   |       |          |   |                                      |       |          |                                      |                             |       |          |                             |            |       |          |            |       |    |
|           |   |  | KRS0090A           | HEATING ELEMENT<br>1.26kW               | <table border="1"> <thead> <tr> <th>Code</th> <th>Description</th> <th>Qty</th> <th>UOM</th> </tr> </thead> <tbody> <tr> <td>GN1326A1</td> <td>ELEMENT<br/>SEALING</td> <td>1.000</td> <td>PC</td> </tr> <tr> <td>RS0090A0</td> <td>CIRC. HEAT.<br/>ELEMENT<br/>1260W 220-230</td> <td>1.000</td> <td>PC</td> </tr> <tr> <td>VI1220A1</td> <td>4,2x12 TCB<br/>SELF-TAPPIN<br/>G SCREW</td> <td>3.000</td> <td>PC</td> </tr> <tr> <td>VM1794A0</td> <td>250x4.8 PA66<br/>BLACK CLAMP</td> <td>2.000</td> <td>PC</td> </tr> <tr> <td>VM2103A0</td> <td>CLAMP LOCK</td> <td>2.000</td> <td>PC</td> </tr> </tbody> </table> | Code                                 | Description | Qty                | UOM   | GN1326A1 | ELEMENT<br>SEALING                   | 1.000   | PC    | RS0090A0 | CIRC. HEAT.<br>ELEMENT<br>1260W 220-230 | 1.000                                | PC    | VI1220A1 | 4,2x12 TCB<br>SELF-TAPPIN<br>G SCREW | 3.000                       | PC    | VM1794A0 | 250x4.8 PA66<br>BLACK CLAMP | 2.000      | PC    | VM2103A0 | CLAMP LOCK | 2.000 | PC |
|           |   |  |                    |   | Code  | Description                          | Qty         | UOM                |       |          |                                      |   |       |          |   |                                      |       |          |                                      |                             |       |          |                             |            |       |          |            |       |    |
|           |   |  |                    |   | GN1326A1  | ELEMENT<br>SEALING                   | 1.000       | PC                 |       |          |                                      |   |       |          |   |                                      |       |          |                                      |                             |       |          |                             |            |       |          |            |       |    |
|           |   |  | RS0090A0           | CIRC. HEAT.<br>ELEMENT<br>1260W 220-230 | 1.000   | PC                                   |             |                    |       |          |                                      |   |       |          |   |                                      |       |          |                                      |                             |       |          |                             |            |       |          |            |       |    |
|           |   |  | VI1220A1           | 4,2x12 TCB<br>SELF-TAPPIN<br>G SCREW    | 3.000   | PC                                   |             |                    |       |          |                                      |   |       |          |   |                                      |       |          |                                      |                             |       |          |                             |            |       |          |            |       |    |
|           |   |  | VM1794A0           | 250x4.8 PA66<br>BLACK CLAMP             | 2.000   | PC                                   |             |                    |       |          |                                      |   |       |          |   |                                      |       |          |                                      |                             |       |          |                             |            |       |          |            |       |    |
|           |   |  | VM2103A0           | CLAMP LOCK                              | 2.000   | PC                                   |             |                    |       |          |                                      |   |       |          |   |                                      |       |          |                                      |                             |       |          |                             |            |       |          |            |       |    |
| KRS0050A  | HEATING ELEMENT<br>KIT 0.5kW                  | <table border="1"> <thead> <tr> <th>Code</th> <th>Description</th> <th>Qty</th> <th>UOM</th> </tr> </thead> <tbody> <tr> <td>GN1326A1</td> <td>ELEMENT<br/>SEALING</td> <td>1.000</td> <td>PC</td> </tr> <tr> <td>RS0050A0</td> <td>HEAT.<br/>ELEMENT<br/>500W<br/>220-230V LIEV</td> <td>1.000</td> <td>PC</td> </tr> <tr> <td>VI1220A1</td> <td>4,2x12 TCB<br/>SELF-TAPPIN<br/>G SCREW</td> <td>2.000</td> <td>PC</td> </tr> </tbody> </table>   | Code               | Description                             | Qty   | UOM                                  | GN1326A1    | ELEMENT<br>SEALING | 1.000 | PC       | RS0050A0                             | HEAT.<br>ELEMENT<br>500W<br>220-230V LIEV     | 1.000 | PC       | VI1220A1                                | 4,2x12 TCB<br>SELF-TAPPIN<br>G SCREW | 2.000 | PC       |                                      |                             |       |          |                             |            |       |          |            |       |    |
|           |   | Code   | Description        | Qty                                     | UOM   |                                      |             |                    |       |          |                                      |   |       |          |   |                                      |       |          |                                      |                             |       |          |                             |            |       |          |            |       |    |
|           |   | GN1326A1   | ELEMENT<br>SEALING | 1.000                                   | PC  |                                      |             |                    |       |          |                                      |   |       |          |   |                                      |       |          |                                      |                             |       |          |                             |            |       |          |            |       |    |
| RS0050A0  | HEAT.<br>ELEMENT<br>500W<br>220-230V LIEV     | 1.000  | PC                 |   |   |                                      |             |                    |       |          |                                      |   |       |          |   |                                      |       |          |                                      |                             |       |          |                             |            |       |          |            |       |    |
| VI1220A1  | 4,2x12 TCB<br>SELF-TAPPIN<br>G SCREW          | 2.000  | PC                 |   |   |                                      |             |                    |       |          |                                      |   |       |          |   |                                      |       |          |                                      |                             |       |          |                             |            |       |          |            |       |    |
| KRS0011A  | HEATING ELEMENT<br>1.465kW RS0011A            | <table border="1"> <thead> <tr> <th>Code</th> <th>Description</th> <th>Qty</th> <th>UOM</th> </tr> </thead> <tbody> <tr> <td>GN1326A1</td> <td>ELEMENT<br/>SEALING</td> <td>1.000</td> <td>PC</td> </tr> <tr> <td>RS0011A0</td> <td>CIRC.HEAT.<br/>ELEMENT<br/>1465W 220-230</td> <td>1.000</td> <td>PC</td> </tr> <tr> <td>VI1220A1</td> <td>4,2x12 TCB<br/>SELF-TAPPIN<br/>G SCREW</td> <td>3.000</td> <td>PC</td> </tr> <tr> <td>VM1794A0</td> <td>250x4.8 PA66<br/>BLACK CLAMP</td> <td>2.000</td> <td>PC</td> </tr> <tr> <td>VM2103A0</td> <td>CLAMP LOCK</td> <td>2.000</td> <td>PC</td> </tr> </tbody> </table> | Code               | Description                             | Qty   | UOM                                  | GN1326A1    | ELEMENT<br>SEALING | 1.000 | PC       | RS0011A0                             | CIRC.HEAT.<br>ELEMENT<br>1465W 220-230        | 1.000 | PC       | VI1220A1                                | 4,2x12 TCB<br>SELF-TAPPIN<br>G SCREW | 3.000 | PC       | VM1794A0                             | 250x4.8 PA66<br>BLACK CLAMP | 2.000 | PC       | VM2103A0                    | CLAMP LOCK | 2.000 | PC       |            |       |    |
|           |   | Code   | Description        | Qty                                     | UOM   |                                      |             |                    |       |          |                                      |   |       |          |   |                                      |       |          |                                      |                             |       |          |                             |            |       |          |            |       |    |
|           |   | GN1326A1   | ELEMENT<br>SEALING | 1.000                                   | PC  |                                      |             |                    |       |          |                                      |   |       |          |   |                                      |       |          |                                      |                             |       |          |                             |            |       |          |            |       |    |
| RS0011A0  | CIRC.HEAT.<br>ELEMENT<br>1465W 220-230        | 1.000  | PC                 |   |   |                                      |             |                    |       |          |                                      |   |       |          |   |                                      |       |          |                                      |                             |       |          |                             |            |       |          |            |       |    |
| VI1220A1  | 4,2x12 TCB<br>SELF-TAPPIN<br>G SCREW          | 3.000  | PC                 |   |   |                                      |             |                    |       |          |                                      |   |       |          |   |                                      |       |          |                                      |                             |       |          |                             |            |       |          |            |       |    |
| VM1794A0  | 250x4.8 PA66<br>BLACK CLAMP                   | 2.000  | PC                 |   |   |                                      |             |                    |       |          |                                      |   |       |          |   |                                      |       |          |                                      |                             |       |          |                             |            |       |          |            |       |    |
| VM2103A0  | CLAMP LOCK                                    | 2.000  | PC                 |   |   |                                      |             |                    |       |          |                                      |   |       |          |   |                                      |       |          |                                      |                             |       |          |                             |            |       |          |            |       |    |
| KRS0010A  | KIT HEATING<br>ELEMENT RS10010A               | <table border="1"> <thead> <tr> <th>Code</th> <th>Description</th> <th>Qty</th> <th>UOM</th> </tr> </thead> <tbody> <tr> <td>GN1326A1</td> <td>ELEMENT<br/>SEALING</td> <td>1.000</td> <td>PC</td> </tr> <tr> <td>RS0010A0</td> <td>CIRC.HEAT.<br/>ELEMENT<br/>2560W -<br/>220-230 V</td> <td>1.000</td> <td>PC</td> </tr> <tr> <td>VI1220A1</td> <td>4,2x12 TCB<br/>SELF-TAPPIN<br/>G SCREW</td> <td>3.000</td> <td>PC</td> </tr> </tbody> </table>   | Code               | Description                             | Qty   | UOM                                  | GN1326A1    | ELEMENT<br>SEALING | 1.000 | PC       | RS0010A0                             | CIRC.HEAT.<br>ELEMENT<br>2560W -<br>220-230 V | 1.000 | PC       | VI1220A1                                | 4,2x12 TCB<br>SELF-TAPPIN<br>G SCREW | 3.000 | PC       |                                      |                             |       |          |                             |            |       |          |            |       |    |
|           |   | Code   | Description        | Qty                                     | UOM   |                                      |             |                    |       |          |                                      |   |       |          |   |                                      |       |          |                                      |                             |       |          |                             |            |       |          |            |       |    |
|           |   | GN1326A1   | ELEMENT<br>SEALING | 1.000                                   | PC  |                                      |             |                    |       |          |                                      |   |       |          |   |                                      |       |          |                                      |                             |       |          |                             |            |       |          |            |       |    |
| RS0010A0  | CIRC.HEAT.<br>ELEMENT<br>2560W -<br>220-230 V | 1.000  | PC                 |   |   |                                      |             |                    |       |          |                                      |   |       |          |   |                                      |       |          |                                      |                             |       |          |                             |            |       |          |            |       |    |
| VI1220A1  | 4,2x12 TCB<br>SELF-TAPPIN<br>G SCREW          | 3.000  | PC                 |   |   |                                      |             |                    |       |          |                                      |   |       |          |   |                                      |       |          |                                      |                             |       |          |                             |            |       |          |            |       |    |

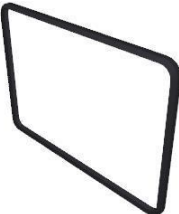



| COMPONENT |                                     |   | SPARE PART |                                    |   |      |             |     |     |          |                                     |         |    |          |                             |       |    |          |                                |       |    |          |                          |       |    |          |            |       |    |
|-----------|-------------------------------------|---|------------|------------------------------------|---|------|-------------|-----|-----|----------|-------------------------------------|---------|----|----------|-----------------------------|-------|----|----------|--------------------------------|-------|----|----------|--------------------------|-------|----|----------|------------|-------|----|
| Code      | Description                         | Image   | Code       | Description                        | Kit components  |      |             |     |     |          |                                     |         |    |          |                             |       |    |          |                                |       |    |          |                          |       |    |          |            |       |    |
| GN1326A   | ELEMENT SEALING                     |    | KG1326A    | HEATING ELEMENT GASKET 5 PCS KIT   | <table border="1"> <thead> <tr> <th>Code</th> <th>Description</th> <th>Qty</th> <th>UOM</th> </tr> </thead> <tbody> <tr> <td>GN1326A1</td> <td>ELEMENT SEALING</td> <td>5.000</td> <td>PC</td> </tr> </tbody> </table>  | Code | Description | Qty | UOM | GN1326A1 | ELEMENT SEALING                     | 5.000   | PC |          |                             |       |    |          |                                |       |    |          |                          |       |    |          |            |       |    |
| Code      | Description                         | Qty   | UOM        |                                    |   |      |             |     |     |          |                                     |         |    |          |                             |       |    |          |                                |       |    |          |                          |       |    |          |            |       |    |
| GN1326A1  | ELEMENT SEALING                     | 5.000   | PC         |                                    |   |      |             |     |     |          |                                     |         |    |          |                             |       |    |          |                                |       |    |          |                          |       |    |          |            |       |    |
| RS1012A   | CIRCULAR ELEMENT 1365W 120V         |    | KRS1012A   | 1365W 120V HEATING ELEMENT KIT     | <table border="1"> <thead> <tr> <th>Code</th> <th>Description</th> <th>Qty</th> <th>UOM</th> </tr> </thead> <tbody> <tr> <td>GN1326A1</td> <td>ELEMENT SEALING</td> <td>1.000</td> <td>PC</td> </tr> <tr> <td>RS1012A0</td> <td>CIRCULAR ELEMENT 1365W 120V</td> <td>1.000</td> <td>PC</td> </tr> <tr> <td>VI1220A1</td> <td>4,2x12 TCB SELF-TAPPIN G SCREW</td> <td>5.000</td> <td>PC</td> </tr> <tr> <td>VM1794A0</td> <td>250x4.8 PA66 BLACK CLAMP</td> <td>2.000</td> <td>PC</td> </tr> <tr> <td>VM2103A0</td> <td>CLAMP LOCK</td> <td>2.000</td> <td>PC</td> </tr> </tbody> </table> | Code | Description | Qty | UOM | GN1326A1 | ELEMENT SEALING                     | 1.000   | PC | RS1012A0 | CIRCULAR ELEMENT 1365W 120V | 1.000 | PC | VI1220A1 | 4,2x12 TCB SELF-TAPPIN G SCREW | 5.000 | PC | VM1794A0 | 250x4.8 PA66 BLACK CLAMP | 2.000 | PC | VM2103A0 | CLAMP LOCK | 2.000 | PC |
| Code      | Description                         | Qty   | UOM        |                                    |   |      |             |     |     |          |                                     |         |    |          |                             |       |    |          |                                |       |    |          |                          |       |    |          |            |       |    |
| GN1326A1  | ELEMENT SEALING                     | 1.000   | PC         |                                    |   |      |             |     |     |          |                                     |         |    |          |                             |       |    |          |                                |       |    |          |                          |       |    |          |            |       |    |
| RS1012A0  | CIRCULAR ELEMENT 1365W 120V         | 1.000   | PC         |                                    |   |      |             |     |     |          |                                     |         |    |          |                             |       |    |          |                                |       |    |          |                          |       |    |          |            |       |    |
| VI1220A1  | 4,2x12 TCB SELF-TAPPIN G SCREW      | 5.000   | PC         |                                    |   |      |             |     |     |          |                                     |         |    |          |                             |       |    |          |                                |       |    |          |                          |       |    |          |            |       |    |
| VM1794A0  | 250x4.8 PA66 BLACK CLAMP            | 2.000   | PC         |                                    |   |      |             |     |     |          |                                     |         |    |          |                             |       |    |          |                                |       |    |          |                          |       |    |          |            |       |    |
| VM2103A0  | CLAMP LOCK                          | 2.000   | PC         |                                    |   |      |             |     |     |          |                                     |         |    |          |                             |       |    |          |                                |       |    |          |                          |       |    |          |            |       |    |
| GN1225A   | LineMicro ROBERTA XF003 DOOR GASKE  |  | KG1225A    | LINEMICRO XF003 DOOR GASKET KIT    | <table border="1"> <thead> <tr> <th>Code</th> <th>Description</th> <th>Qty</th> <th>UOM</th> </tr> </thead> <tbody> <tr> <td>GN1225A0</td> <td>LineMicro ROBERTA XF003 DOOR GASKET</td> <td>1.000</td> <td>PC</td> </tr> </tbody> </table>  | Code | Description | Qty | UOM | GN1225A0 | LineMicro ROBERTA XF003 DOOR GASKET | 1.000   | PC |          |                             |       |    |          |                                |       |    |          |                          |       |    |          |            |       |    |
| Code      | Description                         | Qty   | UOM        |                                    |   |      |             |     |     |          |                                     |         |    |          |                             |       |    |          |                                |       |    |          |                          |       |    |          |            |       |    |
| GN1225A0  | LineMicro ROBERTA XF003 DOOR GASKET | 1.000   | PC         |                                    |   |      |             |     |     |          |                                     |         |    |          |                             |       |    |          |                                |       |    |          |                          |       |    |          |            |       |    |
|           |                                     |   | KG10029A   | LM ROBERTA 100 PCS DOOR GASKET KIT | <table border="1"> <thead> <tr> <th>Code</th> <th>Description</th> <th>Qty</th> <th>UOM</th> </tr> </thead> <tbody> <tr> <td>GN1225A0</td> <td>LineMicro ROBERTA XF003 DOOR GASKET</td> <td>100.000</td> <td>PC</td> </tr> </tbody> </table>  | Code | Description | Qty | UOM | GN1225A0 | LineMicro ROBERTA XF003 DOOR GASKET | 100.000 | PC |          |                             |       |    |          |                                |       |    |          |                          |       |    |          |            |       |    |
| Code      | Description                         | Qty   | UOM        |                                    |   |      |             |     |     |          |                                     |         |    |          |                             |       |    |          |                                |       |    |          |                          |       |    |          |            |       |    |
| GN1225A0  | LineMicro ROBERTA XF003 DOOR GASKET | 100.000   | PC         |                                    |   |      |             |     |     |          |                                     |         |    |          |                             |       |    |          |                                |       |    |          |                          |       |    |          |            |       |    |
| GN1546A   | SHAFT GASKET D8                     |  | KG1546A    | D=8 MOTOR SHAFT GASKET KIT         | <table border="1"> <thead> <tr> <th>Code</th> <th>Description</th> <th>Qty</th> <th>UOM</th> </tr> </thead> <tbody> <tr> <td>GN1546A0</td> <td>SHAFT GASKET D8</td> <td>1.000</td> <td>PC</td> </tr> </tbody> </table>  | Code | Description | Qty | UOM | GN1546A0 | SHAFT GASKET D8                     | 1.000   | PC |          |                             |       |    |          |                                |       |    |          |                          |       |    |          |            |       |    |
| Code      | Description                         | Qty   | UOM        |                                    |   |      |             |     |     |          |                                     |         |    |          |                             |       |    |          |                                |       |    |          |                          |       |    |          |            |       |    |
| GN1546A0  | SHAFT GASKET D8                     | 1.000   | PC         |                                    |   |      |             |     |     |          |                                     |         |    |          |                             |       |    |          |                                |       |    |          |                          |       |    |          |            |       |    |

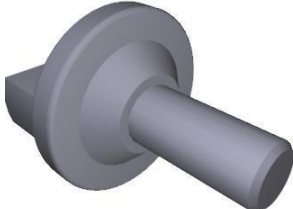

| COMPONENT |                                 |   | SPARE PART |   |   |      |             |     |     |           |                                 |        |    |
|-----------|---------------------------------|---|------------|---|---|------|-------------|-----|-----|-----------|---------------------------------|--------|----|
| Code      | Description                     | Image   | Code       | Description                             | Kit components  |      |             |     |     |           |                                 |        |    |
| GRL1080B  | L/R CHROMIUM PLATED LAT.SUPPORT |    | KGRL1080B  | RIGHT/LEFT XF003 LATERAL SUPPORT KIT    | <table border="1"> <thead> <tr> <th>Code</th> <th>Description</th> <th>Qty</th> <th>UOM</th> </tr> </thead> <tbody> <tr> <td>GRL1080B0</td> <td>L/R CHROMIUM PLATED LAT.SUPPORT</td> <td>2.000</td> <td>PC</td> </tr> </tbody> </table> | Code | Description | Qty | UOM | GRL1080B0 | L/R CHROMIUM PLATED LAT.SUPPORT | 2.000  | PC |
| Code      | Description                     | Qty   | UOM        |   |   |      |             |     |     |           |                                 |        |    |
| GRL1080B0 | L/R CHROMIUM PLATED LAT.SUPPORT | 2.000   | PC         |   |   |      |             |     |     |           |                                 |        |    |
| TB2092A   | LINE MICRO EXHAUST CHIMNEY      |    | TB2092A0   | LINE MICRO EXHAUST CHIMNEY              |   |      |             |     |     |           |                                 |        |    |
| VM1815A   | LATERAL SUPPORTS FIXING BOLT    |  | KVM1815A   | MISS/MICRO/S4/S3 THUMB SCREW 10 PCS KIT | <table border="1"> <thead> <tr> <th>Code</th> <th>Description</th> <th>Qty</th> <th>UOM</th> </tr> </thead> <tbody> <tr> <td>VM1815A0</td> <td>LATERAL SUPPORTS FIXING BOLT</td> <td>10.000</td> <td>PC</td> </tr> </tbody> </table>    | Code | Description | Qty | UOM | VM1815A0  | LATERAL SUPPORTS FIXING BOLT    | 10.000 | PC |
| Code      | Description                     | Qty   | UOM        |   |   |      |             |     |     |           |                                 |        |    |
| VM1815A0  | LATERAL SUPPORTS FIXING BOLT    | 10.000  | PC         |   |   |      |             |     |     |           |                                 |        |    |



**ASM0308B/0.D04 - External cover**

**FRONT**

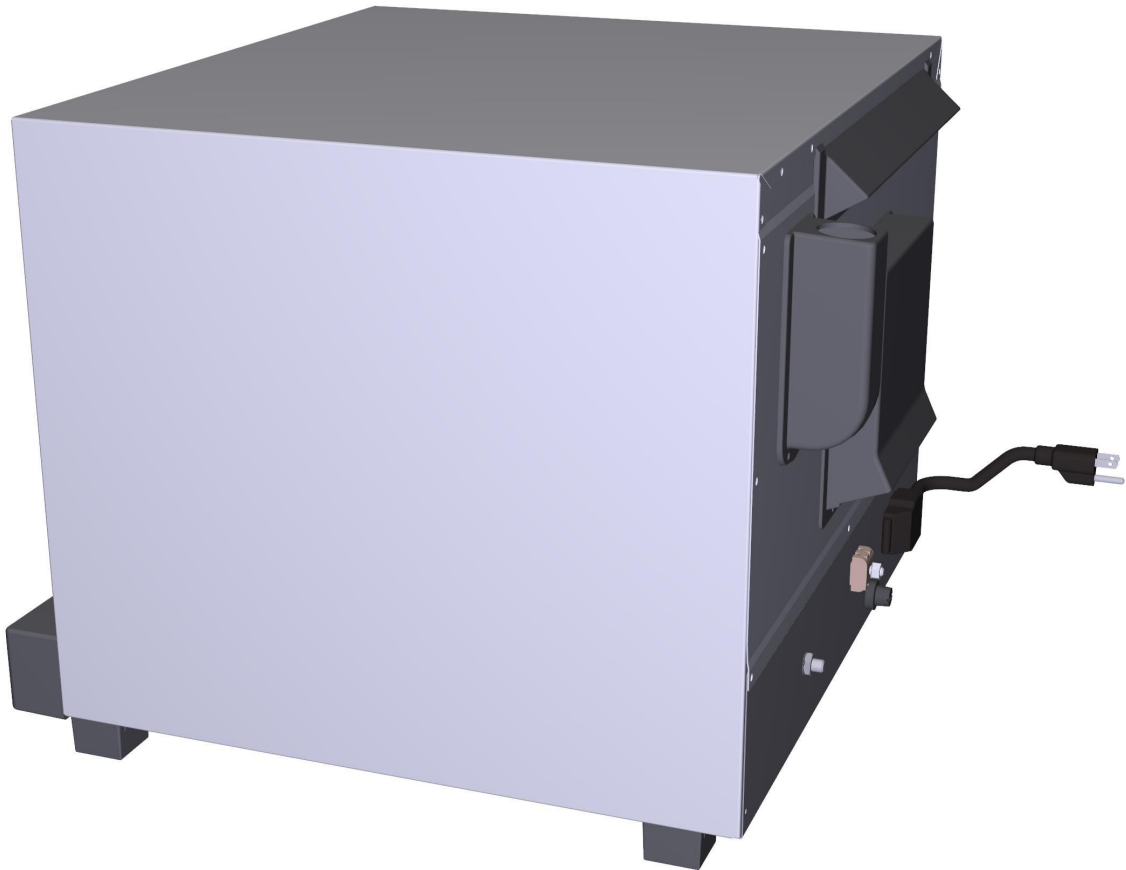





**ASM0308B/0.D04 - External cover**

**REAR**



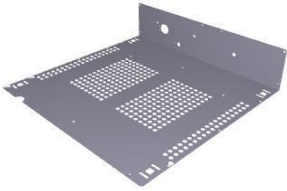

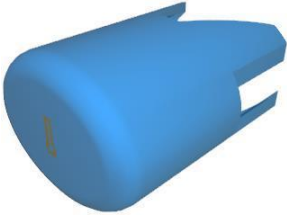
| COMPONENT |   |   | SPARE PART |   |  |      |             |     |     |          |   |       |    |          |   |       |    |          |                   |       |    |          |                       |       |    |          |                                     |       |    |
|-----------|---|---|------------|---|--|------|-------------|-----|-----|----------|---|-------|----|----------|---|-------|----|----------|-------------------|-------|----|----------|-----------------------|-------|----|----------|-------------------------------------|-------|----|
| Code      | Description                                   | Image   | Code       | Description                             | Kit components   |      |             |     |     |          |   |       |    |          |   |       |    |          |                   |       |    |          |                       |       |    |          |                                     |       |    |
| 0D2120A   | LMC ROBERTA<br>EXTERNAL CASING                |    | 0D2120A0   | LMC ROBERTA<br>EXTERNAL CASING          |  |      |             |     |     |          |   |       |    |          |   |       |    |          |                   |       |    |          |                       |       |    |          |                                     |       |    |
| 0E1165B   | ROBERTA BOTTOM<br>PANEL                       |    | 0E1165B1   | ROBERTA BOTTOM<br>PANEL                 |  |      |             |     |     |          |   |       |    |          |   |       |    |          |                   |       |    |          |                       |       |    |          |                                     |       |    |
| 0F1420A   | SCHIENA IP<br>ROBERTA                         |  | 0F1420A1   | SCHIENA IP<br>ROBERTA                   |  |      |             |     |     |          |   |       |    |          |   |       |    |          |                   |       |    |          |                       |       |    |          |                                     |       |    |
| VE1530A   | GOLD<br>THERMOMETER<br>BLUE LIGHT COVER       |  | KLP1012A   | GOLDEN<br>THERMOMETER<br>BLUE LIGHT KIT | <table border="1"> <thead> <tr> <th>Code</th> <th>Description</th> <th>Qty</th> <th>UOM</th> </tr> </thead> <tbody> <tr> <td>VE1170A0</td> <td>D16 OPAQUE<br/>NICKEL<br/>ELLIPTICAL<br/>SUPPORT</td> <td>1.000</td> <td>PC</td> </tr> <tr> <td>VE1530A0</td> <td>GOLD<br/>THERMOMETE<br/>R BLUE LIGHT<br/>COVER</td> <td>1.000</td> <td>PC</td> </tr> <tr> <td>VE1535A1</td> <td>230V WHITE<br/>LED</td> <td>1.000</td> <td>PC</td> </tr> <tr> <td>VM1762A0</td> <td>INNER LAMP<br/>SUPPORT</td> <td>1.000</td> <td>PC</td> </tr> <tr> <td>VM2009A0</td> <td>D16 SILVER<br/>ELLIPTICAL<br/>SUPPORT</td> <td>1.000</td> <td>PC</td> </tr> </tbody> </table> | Code | Description | Qty | UOM | VE1170A0 | D16 OPAQUE<br>NICKEL<br>ELLIPTICAL<br>SUPPORT | 1.000 | PC | VE1530A0 | GOLD<br>THERMOMETE<br>R BLUE LIGHT<br>COVER | 1.000 | PC | VE1535A1 | 230V WHITE<br>LED | 1.000 | PC | VM1762A0 | INNER LAMP<br>SUPPORT | 1.000 | PC | VM2009A0 | D16 SILVER<br>ELLIPTICAL<br>SUPPORT | 1.000 | PC |
| Code      | Description                                   | Qty   | UOM        |   |  |      |             |     |     |          |   |       |    |          |   |       |    |          |                   |       |    |          |                       |       |    |          |                                     |       |    |
| VE1170A0  | D16 OPAQUE<br>NICKEL<br>ELLIPTICAL<br>SUPPORT | 1.000   | PC         |   |  |      |             |     |     |          |   |       |    |          |   |       |    |          |                   |       |    |          |                       |       |    |          |                                     |       |    |
| VE1530A0  | GOLD<br>THERMOMETE<br>R BLUE LIGHT<br>COVER   | 1.000   | PC         |   |  |      |             |     |     |          |   |       |    |          |   |       |    |          |                   |       |    |          |                       |       |    |          |                                     |       |    |
| VE1535A1  | 230V WHITE<br>LED                             | 1.000   | PC         |   |  |      |             |     |     |          |   |       |    |          |   |       |    |          |                   |       |    |          |                       |       |    |          |                                     |       |    |
| VM1762A0  | INNER LAMP<br>SUPPORT                         | 1.000   | PC         |   |  |      |             |     |     |          |   |       |    |          |   |       |    |          |                   |       |    |          |                       |       |    |          |                                     |       |    |
| VM2009A0  | D16 SILVER<br>ELLIPTICAL<br>SUPPORT           | 1.000   | PC         |   |  |      |             |     |     |          |   |       |    |          |   |       |    |          |                   |       |    |          |                       |       |    |          |                                     |       |    |



| COMPONENT |                                      |  | SPARE PART |                                   |  |      |             |                                      |       |          |                                      |                |       |          |                |                    |       |          |                    |                                 |       |          |
|-----------|--------------------------------------|--|------------|-----------------------------------|--|------|-------------|--------------------------------------|-------|----------|--------------------------------------|----------------|-------|----------|----------------|--------------------|-------|----------|--------------------|---------------------------------|-------|----------|
| Code      | Description                          | Image  | Code       | Description                       | Kit components   |      |             |                                      |       |          |                                      |                |       |          |                |                    |       |          |                    |                                 |       |          |
| VE1535A   | 230V WHITE LED                       |   | KVE1535A   | 230V WHITE LED LIGHT 1 PC KIT     | <table border="1"> <thead> <tr> <th>Code</th> <th>Description</th> <th>Qty</th> <th>UOM</th> </tr> </thead> <tbody> <tr> <td>VE1535A1</td> <td>230V WHITE LED</td> <td>1.000</td> <td>PC</td> </tr> </tbody> </table>  | Code | Description | Qty                                  | UOM   | VE1535A1 | 230V WHITE LED                       | 1.000          | PC    |          |                |                    |       |          |                    |                                 |       |          |
|           |                                      |  | Code       | Description                       | Qty  | UOM  |             |                                      |       |          |                                      |                |       |          |                |                    |       |          |                    |                                 |       |          |
|           |                                      |  | VE1535A1   | 230V WHITE LED                    | 1.000  | PC   |             |                                      |       |          |                                      |                |       |          |                |                    |       |          |                    |                                 |       |          |
|           |                                      |  | KVE0105A   | CLOUD LED LIGHT+COVER+SUPPORT KIT | <table border="1"> <thead> <tr> <th>Code</th> <th>Description</th> <th>Qty</th> <th>UOM</th> </tr> </thead> <tbody> <tr> <td>VE1170A0</td> <td>D16 OPAQUE NICKEL ELLIPTICAL SUPPORT</td> <td>1.000</td> <td>PC</td> </tr> <tr> <td>VE1535A1</td> <td>230V WHITE LED</td> <td>1.000</td> <td>PC</td> </tr> <tr> <td>VM1762A0</td> <td>INNER LAMP SUPPORT</td> <td>1.000</td> <td>PC</td> </tr> <tr> <td>VM1903A0</td> <td>GREEN PILOT WITH GOLD "CLOUD"</td> <td>1.000</td> <td>PC</td> </tr> </tbody> </table> | Code | Description | Qty                                  | UOM   | VE1170A0 | D16 OPAQUE NICKEL ELLIPTICAL SUPPORT | 1.000          | PC    | VE1535A1 | 230V WHITE LED | 1.000              | PC    | VM1762A0 | INNER LAMP SUPPORT | 1.000                           | PC    | VM1903A0 |
| Code      | Description                          | Qty  | UOM        |                                   |  |      |             |                                      |       |          |                                      |                |       |          |                |                    |       |          |                    |                                 |       |          |
| VE1170A0  | D16 OPAQUE NICKEL ELLIPTICAL SUPPORT | 1.000  | PC         |                                   |  |      |             |                                      |       |          |                                      |                |       |          |                |                    |       |          |                    |                                 |       |          |
| VE1535A1  | 230V WHITE LED                       | 1.000  | PC         |                                   |  |      |             |                                      |       |          |                                      |                |       |          |                |                    |       |          |                    |                                 |       |          |
| VM1762A0  | INNER LAMP SUPPORT                   | 1.000  | PC         |                                   |  |      |             |                                      |       |          |                                      |                |       |          |                |                    |       |          |                    |                                 |       |          |
| VM1903A0  | GREEN PILOT WITH GOLD "CLOUD"        | 1.000  | PC         |                                   |  |      |             |                                      |       |          |                                      |                |       |          |                |                    |       |          |                    |                                 |       |          |
| KVE0104A  | NEUTRAL GREEN LIGHT KIT              | <table border="1"> <thead> <tr> <th>Code</th> <th>Description</th> <th>Qty</th> <th>UOM</th> </tr> </thead> <tbody> <tr> <td>VE1170A0</td> <td>D16 OPAQUE NICKEL ELLIPTICAL SUPPORT</td> <td>1.000</td> <td>PC</td> </tr> <tr> <td>VE1535A1</td> <td>230V WHITE LED</td> <td>1.000</td> <td>PC</td> </tr> <tr> <td>VM1762A0</td> <td>INNER LAMP SUPPORT</td> <td>1.000</td> <td>PC</td> </tr> <tr> <td>VM1902A0</td> <td>NEUTRAL GREEN PLASTIC COVER FOR</td> <td>1.000</td> <td>PC</td> </tr> </tbody> </table> | Code       | Description                       | Qty  | UOM  | VE1170A0    | D16 OPAQUE NICKEL ELLIPTICAL SUPPORT | 1.000 | PC       | VE1535A1                             | 230V WHITE LED | 1.000 | PC       | VM1762A0       | INNER LAMP SUPPORT | 1.000 | PC       | VM1902A0           | NEUTRAL GREEN PLASTIC COVER FOR | 1.000 | PC       |
| Code      | Description                          | Qty  | UOM        |                                   |  |      |             |                                      |       |          |                                      |                |       |          |                |                    |       |          |                    |                                 |       |          |
| VE1170A0  | D16 OPAQUE NICKEL ELLIPTICAL SUPPORT | 1.000  | PC         |                                   |  |      |             |                                      |       |          |                                      |                |       |          |                |                    |       |          |                    |                                 |       |          |
| VE1535A1  | 230V WHITE LED                       | 1.000  | PC         |                                   |  |      |             |                                      |       |          |                                      |                |       |          |                |                    |       |          |                    |                                 |       |          |
| VM1762A0  | INNER LAMP SUPPORT                   | 1.000  | PC         |                                   |  |      |             |                                      |       |          |                                      |                |       |          |                |                    |       |          |                    |                                 |       |          |
| VM1902A0  | NEUTRAL GREEN PLASTIC COVER FOR      | 1.000  | PC         |                                   |  |      |             |                                      |       |          |                                      |                |       |          |                |                    |       |          |                    |                                 |       |          |
| KVE0102A  | GOLDEN FLAME LIGHT COVER KIT         | <table border="1"> <thead> <tr> <th>Code</th> <th>Description</th> <th>Qty</th> <th>UOM</th> </tr> </thead> <tbody> <tr> <td>VE1170A0</td> <td>D16 OPAQUE NICKEL ELLIPTICAL SUPPORT</td> <td>1.000</td> <td>PC</td> </tr> <tr> <td>VE1535A1</td> <td>230V WHITE LED</td> <td>1.000</td> <td>PC</td> </tr> <tr> <td>VM1762A0</td> <td>INNER LAMP SUPPORT</td> <td>1.000</td> <td>PC</td> </tr> <tr> <td>VM1767A0</td> <td>GREEN PILOT LIGHT W/ GOLD FLAME</td> <td>1.000</td> <td>PC</td> </tr> </tbody> </table> | Code       | Description                       | Qty  | UOM  | VE1170A0    | D16 OPAQUE NICKEL ELLIPTICAL SUPPORT | 1.000 | PC       | VE1535A1                             | 230V WHITE LED | 1.000 | PC       | VM1762A0       | INNER LAMP SUPPORT | 1.000 | PC       | VM1767A0           | GREEN PILOT LIGHT W/ GOLD FLAME | 1.000 | PC       |
| Code      | Description                          | Qty  | UOM        |                                   |  |      |             |                                      |       |          |                                      |                |       |          |                |                    |       |          |                    |                                 |       |          |
| VE1170A0  | D16 OPAQUE NICKEL ELLIPTICAL SUPPORT | 1.000  | PC         |                                   |  |      |             |                                      |       |          |                                      |                |       |          |                |                    |       |          |                    |                                 |       |          |
| VE1535A1  | 230V WHITE LED                       | 1.000  | PC         |                                   |  |      |             |                                      |       |          |                                      |                |       |          |                |                    |       |          |                    |                                 |       |          |
| VM1762A0  | INNER LAMP SUPPORT                   | 1.000  | PC         |                                   |  |      |             |                                      |       |          |                                      |                |       |          |                |                    |       |          |                    |                                 |       |          |
| VM1767A0  | GREEN PILOT LIGHT W/ GOLD FLAME      | 1.000  | PC         |                                   |  |      |             |                                      |       |          |                                      |                |       |          |                |                    |       |          |                    |                                 |       |          |
| KVE0101A  | SINUSOID LIGHT GREEN COVER KIT       | <table border="1"> <thead> <tr> <th>Code</th> <th>Description</th> <th>Qty</th> <th>UOM</th> </tr> </thead> <tbody> <tr> <td>VE1170A0</td> <td>D16 OPAQUE NICKEL ELLIPTICAL SUPPORT</td> <td>1.000</td> <td>PC</td> </tr> <tr> <td>VE1535A1</td> <td>230V WHITE LED</td> <td>1.000</td> <td>PC</td> </tr> <tr> <td>VM1762A0</td> <td>INNER LAMP SUPPORT</td> <td>1.000</td> <td>PC</td> </tr> <tr> <td>VM1765A0</td> <td>GREEN PILOT WITH GOLD SINUSOIDE</td> <td>1.000</td> <td>PC</td> </tr> </tbody> </table> | Code       | Description                       | Qty  | UOM  | VE1170A0    | D16 OPAQUE NICKEL ELLIPTICAL SUPPORT | 1.000 | PC       | VE1535A1                             | 230V WHITE LED | 1.000 | PC       | VM1762A0       | INNER LAMP SUPPORT | 1.000 | PC       | VM1765A0           | GREEN PILOT WITH GOLD SINUSOIDE | 1.000 | PC       |
| Code      | Description                          | Qty  | UOM        |                                   |  |      |             |                                      |       |          |                                      |                |       |          |                |                    |       |          |                    |                                 |       |          |
| VE1170A0  | D16 OPAQUE NICKEL ELLIPTICAL SUPPORT | 1.000  | PC         |                                   |  |      |             |                                      |       |          |                                      |                |       |          |                |                    |       |          |                    |                                 |       |          |
| VE1535A1  | 230V WHITE LED                       | 1.000  | PC         |                                   |  |      |             |                                      |       |          |                                      |                |       |          |                |                    |       |          |                    |                                 |       |          |
| VM1762A0  | INNER LAMP SUPPORT                   | 1.000  | PC         |                                   |  |      |             |                                      |       |          |                                      |                |       |          |                |                    |       |          |                    |                                 |       |          |
| VM1765A0  | GREEN PILOT WITH GOLD SINUSOIDE      | 1.000  | PC         |                                   |  |      |             |                                      |       |          |                                      |                |       |          |                |                    |       |          |                    |                                 |       |          |



| COMPONENT |                                      |   | SPARE PART |                                    |   |      |             |                                      |       |          |                                    |                                    |       |          |                |                                    |       |          |                              |                      |       |          |                    |                        |       |    |          |                              |       |    |          |                    |       |    |          |                              |       |    |
|-----------|--------------------------------------|---|------------|------------------------------------|---|------|-------------|--------------------------------------|-------|----------|------------------------------------|------------------------------------|-------|----------|----------------|------------------------------------|-------|----------|------------------------------|----------------------|-------|----------|--------------------|------------------------|-------|----|----------|------------------------------|-------|----|----------|--------------------|-------|----|----------|------------------------------|-------|----|
| Code      | Description                          | Image   | Code       | Description                        | Kit components  |      |             |                                      |       |          |                                    |                                    |       |          |                |                                    |       |          |                              |                      |       |          |                    |                        |       |    |          |                              |       |    |          |                    |       |    |          |                              |       |    |
| VE1535A   | 230V WHITE LED                       |    | KVE0100A   | THERMOMETER<br>LIGHT COVER KIT     | <table border="1"> <thead> <tr> <th>Code</th> <th>Description</th> <th>Qty</th> <th>UOM</th> </tr> </thead> <tbody> <tr> <td>VE1530A0</td> <td>GOLD THERMOMETE R BLUE LIGHT COVER</td> <td>1.000</td> <td>PC</td> </tr> <tr> <td>VE1535A1</td> <td>230V WHITE LED</td> <td>1.000</td> <td>PC</td> </tr> <tr> <td>VM1761A0</td> <td>D16 BLACK ELLIPTICAL SUPPORT</td> <td>1.000</td> <td>PC</td> </tr> <tr> <td>VM1762A0</td> <td>INNER LAMP SUPPORT</td> <td>1.000</td> <td>PC</td> </tr> </tbody> </table> | Code | Description | Qty                                  | UOM   | VE1530A0 | GOLD THERMOMETE R BLUE LIGHT COVER | 1.000                              | PC    | VE1535A1 | 230V WHITE LED | 1.000                              | PC    | VM1761A0 | D16 BLACK ELLIPTICAL SUPPORT | 1.000                | PC    | VM1762A0 | INNER LAMP SUPPORT | 1.000                  | PC    |    |          |                              |       |    |          |                    |       |    |          |                              |       |    |
|           |                                      |   | Code       | Description                        | Qty   | UOM  |             |                                      |       |          |                                    |                                    |       |          |                |                                    |       |          |                              |                      |       |          |                    |                        |       |    |          |                              |       |    |          |                    |       |    |          |                              |       |    |
|           |                                      |   | VE1530A0   | GOLD THERMOMETE R BLUE LIGHT COVER | 1.000   | PC   |             |                                      |       |          |                                    |                                    |       |          |                |                                    |       |          |                              |                      |       |          |                    |                        |       |    |          |                              |       |    |          |                    |       |    |          |                              |       |    |
| VE1535A1  | 230V WHITE LED                       | 1.000   | PC         |                                    |   |      |             |                                      |       |          |                                    |                                    |       |          |                |                                    |       |          |                              |                      |       |          |                    |                        |       |    |          |                              |       |    |          |                    |       |    |          |                              |       |    |
| VM1761A0  | D16 BLACK ELLIPTICAL SUPPORT         | 1.000   | PC         |                                    |   |      |             |                                      |       |          |                                    |                                    |       |          |                |                                    |       |          |                              |                      |       |          |                    |                        |       |    |          |                              |       |    |          |                    |       |    |          |                              |       |    |
| VM1762A0  | INNER LAMP SUPPORT                   | 1.000   | PC         |                                    |   |      |             |                                      |       |          |                                    |                                    |       |          |                |                                    |       |          |                              |                      |       |          |                    |                        |       |    |          |                              |       |    |          |                    |       |    |          |                              |       |    |
| KVE0011A  | SP KNOBS AND LIGHTS KIT              | <table border="1"> <thead> <tr> <th>Code</th> <th>Description</th> <th>Qty</th> <th>UOM</th> </tr> </thead> <tbody> <tr> <td>MN1105A0</td> <td>120-400C XP THERMOSTAT KNOB</td> <td>1.000</td> <td>PC</td> </tr> <tr> <td>MN1110A0</td> <td>XP NEUTRAL INDEX DIAL</td> <td>1.000</td> <td>PC</td> </tr> <tr> <td>VE1530A0</td> <td>GOLD THERMOMETE R BLUE LIGHT COVER</td> <td>1.000</td> <td>PC</td> </tr> <tr> <td>VE1535A1</td> <td>230V WHITE LED</td> <td>1.000</td> <td>PC</td> </tr> <tr> <td>VE1561A0</td> <td>NA/NA BIPOLAR SWITCH</td> <td>1.000</td> <td>PC</td> </tr> <tr> <td>VM1761A0</td> <td>D16 BLACK ELLIPTICAL SUPPORT</td> <td>2.000</td> <td>PC</td> </tr> <tr> <td>VM1762A0</td> <td>INNER LAMP SUPPORT</td> <td>1.000</td> <td>PC</td> </tr> <tr> <td>VM1776A0</td> <td>"GOLD "0-1" MATT SILVER KEY"</td> <td>1.000</td> <td>PC</td> </tr> </tbody> </table> | Code       | Description                        | Qty   | UOM  | MN1105A0    | 120-400C XP THERMOSTAT KNOB          | 1.000 | PC       | MN1110A0                           | XP NEUTRAL INDEX DIAL              | 1.000 | PC       | VE1530A0       | GOLD THERMOMETE R BLUE LIGHT COVER | 1.000 | PC       | VE1535A1                     | 230V WHITE LED       | 1.000 | PC       | VE1561A0           | NA/NA BIPOLAR SWITCH   | 1.000 | PC | VM1761A0 | D16 BLACK ELLIPTICAL SUPPORT | 2.000 | PC | VM1762A0 | INNER LAMP SUPPORT | 1.000 | PC | VM1776A0 | "GOLD "0-1" MATT SILVER KEY" | 1.000 | PC |
| Code      | Description                          | Qty   | UOM        |                                    |   |      |             |                                      |       |          |                                    |                                    |       |          |                |                                    |       |          |                              |                      |       |          |                    |                        |       |    |          |                              |       |    |          |                    |       |    |          |                              |       |    |
| MN1105A0  | 120-400C XP THERMOSTAT KNOB          | 1.000   | PC         |                                    |   |      |             |                                      |       |          |                                    |                                    |       |          |                |                                    |       |          |                              |                      |       |          |                    |                        |       |    |          |                              |       |    |          |                    |       |    |          |                              |       |    |
| MN1110A0  | XP NEUTRAL INDEX DIAL                | 1.000   | PC         |                                    |   |      |             |                                      |       |          |                                    |                                    |       |          |                |                                    |       |          |                              |                      |       |          |                    |                        |       |    |          |                              |       |    |          |                    |       |    |          |                              |       |    |
| VE1530A0  | GOLD THERMOMETE R BLUE LIGHT COVER   | 1.000   | PC         |                                    |   |      |             |                                      |       |          |                                    |                                    |       |          |                |                                    |       |          |                              |                      |       |          |                    |                        |       |    |          |                              |       |    |          |                    |       |    |          |                              |       |    |
| VE1535A1  | 230V WHITE LED                       | 1.000   | PC         |                                    |   |      |             |                                      |       |          |                                    |                                    |       |          |                |                                    |       |          |                              |                      |       |          |                    |                        |       |    |          |                              |       |    |          |                    |       |    |          |                              |       |    |
| VE1561A0  | NA/NA BIPOLAR SWITCH                 | 1.000   | PC         |                                    |   |      |             |                                      |       |          |                                    |                                    |       |          |                |                                    |       |          |                              |                      |       |          |                    |                        |       |    |          |                              |       |    |          |                    |       |    |          |                              |       |    |
| VM1761A0  | D16 BLACK ELLIPTICAL SUPPORT         | 2.000   | PC         |                                    |   |      |             |                                      |       |          |                                    |                                    |       |          |                |                                    |       |          |                              |                      |       |          |                    |                        |       |    |          |                              |       |    |          |                    |       |    |          |                              |       |    |
| VM1762A0  | INNER LAMP SUPPORT                   | 1.000   | PC         |                                    |   |      |             |                                      |       |          |                                    |                                    |       |          |                |                                    |       |          |                              |                      |       |          |                    |                        |       |    |          |                              |       |    |          |                    |       |    |          |                              |       |    |
| VM1776A0  | "GOLD "0-1" MATT SILVER KEY"         | 1.000   | PC         |                                    |   |      |             |                                      |       |          |                                    |                                    |       |          |                |                                    |       |          |                              |                      |       |          |                    |                        |       |    |          |                              |       |    |          |                    |       |    |          |                              |       |    |
| KVE0008A  | XL PILOT BLUE LIGHTS KIT             | <table border="1"> <thead> <tr> <th>Code</th> <th>Description</th> <th>Qty</th> <th>UOM</th> </tr> </thead> <tbody> <tr> <td>VE1170A0</td> <td>D16 OPAQUE NICKEL ELLIPTICAL SUPPORT</td> <td>3.000</td> <td>PC</td> </tr> <tr> <td>VE1530A0</td> <td>GOLD THERMOMETE R BLUE LIGHT COVER</td> <td>1.000</td> <td>PC</td> </tr> <tr> <td>VE1535A1</td> <td>230V WHITE LED</td> <td>1.000</td> <td>PC</td> </tr> <tr> <td>VE1561A0</td> <td>NA/NA BIPOLAR SWITCH</td> <td>1.000</td> <td>PC</td> </tr> <tr> <td>VE1562A0</td> <td>UNIPOLAR NA PUSH BUTTO</td> <td>1.000</td> <td>PC</td> </tr> <tr> <td>VM1762A0</td> <td>INNER LAMP SUPPORT</td> <td>1.000</td> <td>PC</td> </tr> </tbody> </table>   | Code       | Description                        | Qty   | UOM  | VE1170A0    | D16 OPAQUE NICKEL ELLIPTICAL SUPPORT | 3.000 | PC       | VE1530A0                           | GOLD THERMOMETE R BLUE LIGHT COVER | 1.000 | PC       | VE1535A1       | 230V WHITE LED                     | 1.000 | PC       | VE1561A0                     | NA/NA BIPOLAR SWITCH | 1.000 | PC       | VE1562A0           | UNIPOLAR NA PUSH BUTTO | 1.000 | PC | VM1762A0 | INNER LAMP SUPPORT           | 1.000 | PC |          |                    |       |    |          |                              |       |    |
| Code      | Description                          | Qty   | UOM        |                                    |   |      |             |                                      |       |          |                                    |                                    |       |          |                |                                    |       |          |                              |                      |       |          |                    |                        |       |    |          |                              |       |    |          |                    |       |    |          |                              |       |    |
| VE1170A0  | D16 OPAQUE NICKEL ELLIPTICAL SUPPORT | 3.000   | PC         |                                    |   |      |             |                                      |       |          |                                    |                                    |       |          |                |                                    |       |          |                              |                      |       |          |                    |                        |       |    |          |                              |       |    |          |                    |       |    |          |                              |       |    |
| VE1530A0  | GOLD THERMOMETE R BLUE LIGHT COVER   | 1.000   | PC         |                                    |   |      |             |                                      |       |          |                                    |                                    |       |          |                |                                    |       |          |                              |                      |       |          |                    |                        |       |    |          |                              |       |    |          |                    |       |    |          |                              |       |    |
| VE1535A1  | 230V WHITE LED                       | 1.000   | PC         |                                    |   |      |             |                                      |       |          |                                    |                                    |       |          |                |                                    |       |          |                              |                      |       |          |                    |                        |       |    |          |                              |       |    |          |                    |       |    |          |                              |       |    |
| VE1561A0  | NA/NA BIPOLAR SWITCH                 | 1.000   | PC         |                                    |   |      |             |                                      |       |          |                                    |                                    |       |          |                |                                    |       |          |                              |                      |       |          |                    |                        |       |    |          |                              |       |    |          |                    |       |    |          |                              |       |    |
| VE1562A0  | UNIPOLAR NA PUSH BUTTO               | 1.000   | PC         |                                    |   |      |             |                                      |       |          |                                    |                                    |       |          |                |                                    |       |          |                              |                      |       |          |                    |                        |       |    |          |                              |       |    |          |                    |       |    |          |                              |       |    |
| VM1762A0  | INNER LAMP SUPPORT                   | 1.000   | PC         |                                    |   |      |             |                                      |       |          |                                    |                                    |       |          |                |                                    |       |          |                              |                      |       |          |                    |                        |       |    |          |                              |       |    |          |                    |       |    |          |                              |       |    |



| COMPONENT |                                      |  | SPARE PART |                          |  |      |             |                                      |       |          |                                   |                                    |       |          |                              |                                |       |    |          |                        |       |    |          |                                |       |    |          |                    |       |    |          |                                 |       |    |          |                                 |       |    |          |                                   |       |    |          |                                 |       |    |          |                               |       |    |
|-----------|--------------------------------------|--|------------|--------------------------|--|------|-------------|--------------------------------------|-------|----------|-----------------------------------|------------------------------------|-------|----------|------------------------------|--------------------------------|-------|----|----------|------------------------|-------|----|----------|--------------------------------|-------|----|----------|--------------------|-------|----|----------|---------------------------------|-------|----|----------|---------------------------------|-------|----|----------|-----------------------------------|-------|----|----------|---------------------------------|-------|----|----------|-------------------------------|-------|----|
| Code      | Description                          | Image  | Code       | Description              | Kit components   |      |             |                                      |       |          |                                   |                                    |       |          |                              |                                |       |    |          |                        |       |    |          |                                |       |    |          |                    |       |    |          |                                 |       |    |          |                                 |       |    |          |                                   |       |    |          |                                 |       |    |          |                               |       |    |
| VE1535A   | 230V WHITE LED                       |   | KVE0008A   | XL PILOT BLUE LIGHTS KIT | <table border="1"> <thead> <tr> <th>Code</th> <th>Description</th> <th>Qty</th> <th>UOM</th> </tr> </thead> <tbody> <tr> <td>VM1775A0</td> <td>OPAQUE SILVER KEY WITH GOLD CLOUD</td> <td>1.000</td> <td>PC</td> </tr> <tr> <td>VM1776A0</td> <td>"GOLD "0-1" MATT SILVER KEY"</td> <td>1.000</td> <td>PC</td> </tr> </tbody> </table> | Code | Description | Qty                                  | UOM   | VM1775A0 | OPAQUE SILVER KEY WITH GOLD CLOUD | 1.000                              | PC    | VM1776A0 | "GOLD "0-1" MATT SILVER KEY" | 1.000                          | PC    |    |          |                        |       |    |          |                                |       |    |          |                    |       |    |          |                                 |       |    |          |                                 |       |    |          |                                   |       |    |          |                                 |       |    |          |                               |       |    |
|           |                                      |  | Code       | Description              | Qty  | UOM  |             |                                      |       |          |                                   |                                    |       |          |                              |                                |       |    |          |                        |       |    |          |                                |       |    |          |                    |       |    |          |                                 |       |    |          |                                 |       |    |          |                                   |       |    |          |                                 |       |    |          |                               |       |    |
| VM1775A0  | OPAQUE SILVER KEY WITH GOLD CLOUD    | 1.000  | PC         |                          |  |      |             |                                      |       |          |                                   |                                    |       |          |                              |                                |       |    |          |                        |       |    |          |                                |       |    |          |                    |       |    |          |                                 |       |    |          |                                 |       |    |          |                                   |       |    |          |                                 |       |    |          |                               |       |    |
| VM1776A0  | "GOLD "0-1" MATT SILVER KEY"         | 1.000  | PC         |                          |  |      |             |                                      |       |          |                                   |                                    |       |          |                              |                                |       |    |          |                        |       |    |          |                                |       |    |          |                    |       |    |          |                                 |       |    |          |                                 |       |    |          |                                   |       |    |          |                                 |       |    |          |                               |       |    |
| KVE0007A  | XF-XG LED AND LED COVERS KIT         | <table border="1"> <thead> <tr> <th>Code</th> <th>Description</th> <th>Qty</th> <th>UOM</th> </tr> </thead> <tbody> <tr> <td>VE1170A0</td> <td>D16 OPAQUE NICKEL ELLIPTICAL SUPPORT</td> <td>5.000</td> <td>PC</td> </tr> <tr> <td>VE1530A0</td> <td>GOLD THERMOMETE R BLUE LIGHT COVER</td> <td>1.000</td> <td>PC</td> </tr> <tr> <td>VE1535A1</td> <td>230V WHITE LED</td> <td>1.000</td> <td>PC</td> </tr> <tr> <td>VE1562A0</td> <td>UNIPOLAR NA PUSH BUTTO</td> <td>1.000</td> <td>PC</td> </tr> <tr> <td>VE1585A0</td> <td>BLUE LIGHT COVER GOLD SINUSOID</td> <td>1.000</td> <td>PC</td> </tr> <tr> <td>VM1782A0</td> <td>INNER LAMP SUPPORT</td> <td>4.000</td> <td>PC</td> </tr> <tr> <td>VM1767A0</td> <td>GREEN PILOT LIGHT W/ GOLD FLAME</td> <td>1.000</td> <td>PC</td> </tr> <tr> <td>VM1774A0</td> <td>SILVER OPAQUE KEY W/ GOLD FLAME</td> <td>1.000</td> <td>PC</td> </tr> <tr> <td>VM1775A0</td> <td>OPAQUE SILVER KEY WITH GOLD CLOUD</td> <td>1.000</td> <td>PC</td> </tr> <tr> <td>VM1902A0</td> <td>NEUTRAL GREEN PLASTIC COVER FOR</td> <td>1.000</td> <td>PC</td> </tr> <tr> <td>VM1903A0</td> <td>GREEN PILOT WITH GOLD "CLOUD"</td> <td>1.000</td> <td>PC</td> </tr> </tbody> </table> | Code       | Description              | Qty  | UOM  | VE1170A0    | D16 OPAQUE NICKEL ELLIPTICAL SUPPORT | 5.000 | PC       | VE1530A0                          | GOLD THERMOMETE R BLUE LIGHT COVER | 1.000 | PC       | VE1535A1                     | 230V WHITE LED                 | 1.000 | PC | VE1562A0 | UNIPOLAR NA PUSH BUTTO | 1.000 | PC | VE1585A0 | BLUE LIGHT COVER GOLD SINUSOID | 1.000 | PC | VM1782A0 | INNER LAMP SUPPORT | 4.000 | PC | VM1767A0 | GREEN PILOT LIGHT W/ GOLD FLAME | 1.000 | PC | VM1774A0 | SILVER OPAQUE KEY W/ GOLD FLAME | 1.000 | PC | VM1775A0 | OPAQUE SILVER KEY WITH GOLD CLOUD | 1.000 | PC | VM1902A0 | NEUTRAL GREEN PLASTIC COVER FOR | 1.000 | PC | VM1903A0 | GREEN PILOT WITH GOLD "CLOUD" | 1.000 | PC |
| Code      | Description                          | Qty  | UOM        |                          |  |      |             |                                      |       |          |                                   |                                    |       |          |                              |                                |       |    |          |                        |       |    |          |                                |       |    |          |                    |       |    |          |                                 |       |    |          |                                 |       |    |          |                                   |       |    |          |                                 |       |    |          |                               |       |    |
| VE1170A0  | D16 OPAQUE NICKEL ELLIPTICAL SUPPORT | 5.000  | PC         |                          |  |      |             |                                      |       |          |                                   |                                    |       |          |                              |                                |       |    |          |                        |       |    |          |                                |       |    |          |                    |       |    |          |                                 |       |    |          |                                 |       |    |          |                                   |       |    |          |                                 |       |    |          |                               |       |    |
| VE1530A0  | GOLD THERMOMETE R BLUE LIGHT COVER   | 1.000  | PC         |                          |  |      |             |                                      |       |          |                                   |                                    |       |          |                              |                                |       |    |          |                        |       |    |          |                                |       |    |          |                    |       |    |          |                                 |       |    |          |                                 |       |    |          |                                   |       |    |          |                                 |       |    |          |                               |       |    |
| VE1535A1  | 230V WHITE LED                       | 1.000  | PC         |                          |  |      |             |                                      |       |          |                                   |                                    |       |          |                              |                                |       |    |          |                        |       |    |          |                                |       |    |          |                    |       |    |          |                                 |       |    |          |                                 |       |    |          |                                   |       |    |          |                                 |       |    |          |                               |       |    |
| VE1562A0  | UNIPOLAR NA PUSH BUTTO               | 1.000  | PC         |                          |  |      |             |                                      |       |          |                                   |                                    |       |          |                              |                                |       |    |          |                        |       |    |          |                                |       |    |          |                    |       |    |          |                                 |       |    |          |                                 |       |    |          |                                   |       |    |          |                                 |       |    |          |                               |       |    |
| VE1585A0  | BLUE LIGHT COVER GOLD SINUSOID       | 1.000  | PC         |                          |  |      |             |                                      |       |          |                                   |                                    |       |          |                              |                                |       |    |          |                        |       |    |          |                                |       |    |          |                    |       |    |          |                                 |       |    |          |                                 |       |    |          |                                   |       |    |          |                                 |       |    |          |                               |       |    |
| VM1782A0  | INNER LAMP SUPPORT                   | 4.000  | PC         |                          |  |      |             |                                      |       |          |                                   |                                    |       |          |                              |                                |       |    |          |                        |       |    |          |                                |       |    |          |                    |       |    |          |                                 |       |    |          |                                 |       |    |          |                                   |       |    |          |                                 |       |    |          |                               |       |    |
| VM1767A0  | GREEN PILOT LIGHT W/ GOLD FLAME      | 1.000  | PC         |                          |  |      |             |                                      |       |          |                                   |                                    |       |          |                              |                                |       |    |          |                        |       |    |          |                                |       |    |          |                    |       |    |          |                                 |       |    |          |                                 |       |    |          |                                   |       |    |          |                                 |       |    |          |                               |       |    |
| VM1774A0  | SILVER OPAQUE KEY W/ GOLD FLAME      | 1.000  | PC         |                          |  |      |             |                                      |       |          |                                   |                                    |       |          |                              |                                |       |    |          |                        |       |    |          |                                |       |    |          |                    |       |    |          |                                 |       |    |          |                                 |       |    |          |                                   |       |    |          |                                 |       |    |          |                               |       |    |
| VM1775A0  | OPAQUE SILVER KEY WITH GOLD CLOUD    | 1.000  | PC         |                          |  |      |             |                                      |       |          |                                   |                                    |       |          |                              |                                |       |    |          |                        |       |    |          |                                |       |    |          |                    |       |    |          |                                 |       |    |          |                                 |       |    |          |                                   |       |    |          |                                 |       |    |          |                               |       |    |
| VM1902A0  | NEUTRAL GREEN PLASTIC COVER FOR      | 1.000  | PC         |                          |  |      |             |                                      |       |          |                                   |                                    |       |          |                              |                                |       |    |          |                        |       |    |          |                                |       |    |          |                    |       |    |          |                                 |       |    |          |                                 |       |    |          |                                   |       |    |          |                                 |       |    |          |                               |       |    |
| VM1903A0  | GREEN PILOT WITH GOLD "CLOUD"        | 1.000  | PC         |                          |  |      |             |                                      |       |          |                                   |                                    |       |          |                              |                                |       |    |          |                        |       |    |          |                                |       |    |          |                    |       |    |          |                                 |       |    |          |                                 |       |    |          |                                   |       |    |          |                                 |       |    |          |                               |       |    |
| KLP1014A  | SINUSOID LED LIGHT+COVER+SUPPORT KIT | <table border="1"> <thead> <tr> <th>Code</th> <th>Description</th> <th>Qty</th> <th>UOM</th> </tr> </thead> <tbody> <tr> <td>VE1170A0</td> <td>D16 OPAQUE NICKEL ELLIPTICAL SUPPORT</td> <td>2.000</td> <td>PC</td> </tr> <tr> <td>VE1535A1</td> <td>230V WHITE LED</td> <td>2.000</td> <td>PC</td> </tr> <tr> <td>VE1585A0</td> <td>BLUE LIGHT COVER GOLD SINUSOID</td> <td>2.000</td> <td>PC</td> </tr> </tbody> </table>  | Code       | Description              | Qty  | UOM  | VE1170A0    | D16 OPAQUE NICKEL ELLIPTICAL SUPPORT | 2.000 | PC       | VE1535A1                          | 230V WHITE LED                     | 2.000 | PC       | VE1585A0                     | BLUE LIGHT COVER GOLD SINUSOID | 2.000 | PC |          |                        |       |    |          |                                |       |    |          |                    |       |    |          |                                 |       |    |          |                                 |       |    |          |                                   |       |    |          |                                 |       |    |          |                               |       |    |
| Code      | Description                          | Qty  | UOM        |                          |  |      |             |                                      |       |          |                                   |                                    |       |          |                              |                                |       |    |          |                        |       |    |          |                                |       |    |          |                    |       |    |          |                                 |       |    |          |                                 |       |    |          |                                   |       |    |          |                                 |       |    |          |                               |       |    |
| VE1170A0  | D16 OPAQUE NICKEL ELLIPTICAL SUPPORT | 2.000  | PC         |                          |  |      |             |                                      |       |          |                                   |                                    |       |          |                              |                                |       |    |          |                        |       |    |          |                                |       |    |          |                    |       |    |          |                                 |       |    |          |                                 |       |    |          |                                   |       |    |          |                                 |       |    |          |                               |       |    |
| VE1535A1  | 230V WHITE LED                       | 2.000  | PC         |                          |  |      |             |                                      |       |          |                                   |                                    |       |          |                              |                                |       |    |          |                        |       |    |          |                                |       |    |          |                    |       |    |          |                                 |       |    |          |                                 |       |    |          |                                   |       |    |          |                                 |       |    |          |                               |       |    |
| VE1585A0  | BLUE LIGHT COVER GOLD SINUSOID       | 2.000  | PC         |                          |  |      |             |                                      |       |          |                                   |                                    |       |          |                              |                                |       |    |          |                        |       |    |          |                                |       |    |          |                    |       |    |          |                                 |       |    |          |                                 |       |    |          |                                   |       |    |          |                                 |       |    |          |                               |       |    |



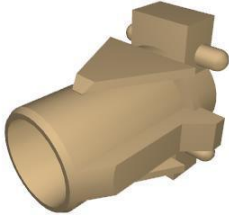

| COMPONENT |   |  | SPARE PART |   |  |      |             |   |       |          |                       |   |       |          |                                     |                       |       |    |          |  |       |    |          |                                     |       |    |
|-----------|---|--|------------|---|--|------|-------------|---|-------|----------|-----------------------|---|-------|----------|-------------------------------------|-----------------------|-------|----|----------|--|-------|----|----------|-------------------------------------|-------|----|
| Code      | Description                                   | Image  | Code       | Description                                 | Kit components   |      |             |   |       |          |                       |   |       |          |                                     |                       |       |    |          |  |       |    |          |                                     |       |    |
| VE1535A   | 230V WHITE LED                                |   | KLP1014A   | SINUSOID LED<br>LIGHT+COVER+SUP<br>PORT KIT | <table border="1"> <thead> <tr> <th>Code</th> <th>Description</th> <th>Qty</th> <th>UOM</th> </tr> </thead> <tbody> <tr> <td>VM1762A0</td> <td>INNER LAMP<br/>SUPPORT</td> <td>2.000</td> <td>PC</td> </tr> <tr> <td>VM2009A0</td> <td>D16 SILVER<br/>ELLIPTICAL<br/>SUPPORT</td> <td>1.000</td> <td>PC</td> </tr> </tbody> </table> | Code | Description | Qty   | UOM   | VM1762A0 | INNER LAMP<br>SUPPORT | 2.000                                       | PC    | VM2009A0 | D16 SILVER<br>ELLIPTICAL<br>SUPPORT | 1.000                 | PC    |    |          |  |       |    |          |                                     |       |    |
|           |   |  | Code       | Description                                 | Qty  | UOM  |             |   |       |          |                       |   |       |          |                                     |                       |       |    |          |  |       |    |          |                                     |       |    |
|           |   |  | VM1762A0   | INNER LAMP<br>SUPPORT                       | 2.000  | PC   |             |   |       |          |                       |   |       |          |                                     |                       |       |    |          |  |       |    |          |                                     |       |    |
| VM2009A0  | D16 SILVER<br>ELLIPTICAL<br>SUPPORT           | 1.000  | PC         |   |  |      |             |   |       |          |                       |   |       |          |                                     |                       |       |    |          |  |       |    |          |                                     |       |    |
| KLP1012A  | GOLDEN<br>THERMOMETER<br>BLUE LIGHT KIT       | <table border="1"> <thead> <tr> <th>Code</th> <th>Description</th> <th>Qty</th> <th>UOM</th> </tr> </thead> <tbody> <tr> <td>VE1170A0</td> <td>D16 OPAQUE<br/>NICKEL<br/>ELLIPTICAL<br/>SUPPORT</td> <td>1.000</td> <td>PC</td> </tr> <tr> <td>VE1530A0</td> <td>GOLD<br/>THERMOMETE<br/>R BLUE LIGHT<br/>COVER</td> <td>1.000</td> <td>PC</td> </tr> <tr> <td>VE1535A1</td> <td>230V WHITE<br/>LED</td> <td>1.000</td> <td>PC</td> </tr> <tr> <td>VM1762A0</td> <td>INNER LAMP<br/>SUPPORT</td> <td>1.000</td> <td>PC</td> </tr> <tr> <td>VM2009A0</td> <td>D16 SILVER<br/>ELLIPTICAL<br/>SUPPORT</td> <td>1.000</td> <td>PC</td> </tr> </tbody> </table> | Code       | Description                                 | Qty  | UOM  | VE1170A0    | D16 OPAQUE<br>NICKEL<br>ELLIPTICAL<br>SUPPORT | 1.000 | PC       | VE1530A0              | GOLD<br>THERMOMETE<br>R BLUE LIGHT<br>COVER | 1.000 | PC       | VE1535A1                            | 230V WHITE<br>LED     | 1.000 | PC | VM1762A0 | INNER LAMP<br>SUPPORT                  | 1.000 | PC | VM2009A0 | D16 SILVER<br>ELLIPTICAL<br>SUPPORT | 1.000 | PC |
| Code      | Description                                   | Qty  | UOM        |   |  |      |             |   |       |          |                       |   |       |          |                                     |                       |       |    |          |  |       |    |          |                                     |       |    |
| VE1170A0  | D16 OPAQUE<br>NICKEL<br>ELLIPTICAL<br>SUPPORT | 1.000  | PC         |   |  |      |             |   |       |          |                       |   |       |          |                                     |                       |       |    |          |  |       |    |          |                                     |       |    |
| VE1530A0  | GOLD<br>THERMOMETE<br>R BLUE LIGHT<br>COVER   | 1.000  | PC         |   |  |      |             |   |       |          |                       |   |       |          |                                     |                       |       |    |          |  |       |    |          |                                     |       |    |
| VE1535A1  | 230V WHITE<br>LED                             | 1.000  | PC         |   |  |      |             |   |       |          |                       |   |       |          |                                     |                       |       |    |          |  |       |    |          |                                     |       |    |
| VM1762A0  | INNER LAMP<br>SUPPORT                         | 1.000  | PC         |   |  |      |             |   |       |          |                       |   |       |          |                                     |                       |       |    |          |  |       |    |          |                                     |       |    |
| VM2009A0  | D16 SILVER<br>ELLIPTICAL<br>SUPPORT           | 1.000  | PC         |   |  |      |             |   |       |          |                       |   |       |          |                                     |                       |       |    |          |  |       |    |          |                                     |       |    |
| KLP1010A  | THERMOSTAT<br>GREEN LIGHT KIT                 | <table border="1"> <thead> <tr> <th>Code</th> <th>Description</th> <th>Qty</th> <th>UOM</th> </tr> </thead> <tbody> <tr> <td>VE1170A0</td> <td>D16 OPAQUE<br/>NICKEL<br/>ELLIPTICAL<br/>SUPPORT</td> <td>1.000</td> <td>PC</td> </tr> <tr> <td>VE1535A1</td> <td>230V WHITE<br/>LED</td> <td>1.000</td> <td>PC</td> </tr> <tr> <td>VM1762A0</td> <td>INNER LAMP<br/>SUPPORT</td> <td>1.000</td> <td>PC</td> </tr> <tr> <td>VM1764A0</td> <td>GREEN PILOT<br/>WITH GOLD<br/>THERMOMETE</td> <td>1.000</td> <td>PC</td> </tr> </tbody> </table>  | Code       | Description                                 | Qty  | UOM  | VE1170A0    | D16 OPAQUE<br>NICKEL<br>ELLIPTICAL<br>SUPPORT | 1.000 | PC       | VE1535A1              | 230V WHITE<br>LED                           | 1.000 | PC       | VM1762A0                            | INNER LAMP<br>SUPPORT | 1.000 | PC | VM1764A0 | GREEN PILOT<br>WITH GOLD<br>THERMOMETE | 1.000 | PC |          |                                     |       |    |
| Code      | Description                                   | Qty  | UOM        |   |  |      |             |   |       |          |                       |   |       |          |                                     |                       |       |    |          |  |       |    |          |                                     |       |    |
| VE1170A0  | D16 OPAQUE<br>NICKEL<br>ELLIPTICAL<br>SUPPORT | 1.000  | PC         |   |  |      |             |   |       |          |                       |   |       |          |                                     |                       |       |    |          |  |       |    |          |                                     |       |    |
| VE1535A1  | 230V WHITE<br>LED                             | 1.000  | PC         |   |  |      |             |   |       |          |                       |   |       |          |                                     |                       |       |    |          |  |       |    |          |                                     |       |    |
| VM1762A0  | INNER LAMP<br>SUPPORT                         | 1.000  | PC         |   |  |      |             |   |       |          |                       |   |       |          |                                     |                       |       |    |          |  |       |    |          |                                     |       |    |
| VM1764A0  | GREEN PILOT<br>WITH GOLD<br>THERMOMETE        | 1.000  | PC         |   |  |      |             |   |       |          |                       |   |       |          |                                     |                       |       |    |          |  |       |    |          |                                     |       |    |
| VM1762A   | INNER LAMP<br>SUPPORT                         |   | KVM1762A   | LAMP INTERNAL<br>SUPPORT KIT                | <table border="1"> <thead> <tr> <th>Code</th> <th>Description</th> <th>Qty</th> <th>UOM</th> </tr> </thead> <tbody> <tr> <td>VM1762A0</td> <td>INNER LAMP<br/>SUPPORT</td> <td>1.000</td> <td>PC</td> </tr> </tbody> </table>  | Code | Description | Qty   | UOM   | VM1762A0 | INNER LAMP<br>SUPPORT | 1.000                                       | PC    |          |                                     |                       |       |    |          |  |       |    |          |                                     |       |    |
| Code      | Description                                   | Qty  | UOM        |   |  |      |             |   |       |          |                       |   |       |          |                                     |                       |       |    |          |  |       |    |          |                                     |       |    |
| VM1762A0  | INNER LAMP<br>SUPPORT                         | 1.000  | PC         |   |  |      |             |   |       |          |                       |   |       |          |                                     |                       |       |    |          |  |       |    |          |                                     |       |    |







| COMPONENT |                                      |  | SPARE PART |                                       |   |      |             |                                      |       |          |                               |                                  |       |          |                                |                                      |       |          |                |                               |       |          |              |       |    |
|-----------|--------------------------------------|--|------------|---------------------------------------|---|------|-------------|--------------------------------------|-------|----------|-------------------------------|----------------------------------|-------|----------|--------------------------------|--------------------------------------|-------|----------|----------------|-------------------------------|-------|----------|--------------|-------|----|
| Code      | Description                          | Image  | Code       | Description                           | Kit components  |      |             |                                      |       |          |                               |                                  |       |          |                                |                                      |       |          |                |                               |       |          |              |       |    |
| VM2009A   | D16 SILVER ELLIPTICAL SUPPORT        |   | KVM2009A   | D16 SILVER ELLIPTICAL SUPPORT KIT     | <table border="1"> <thead> <tr> <th>Code</th> <th>Description</th> <th>Qty</th> <th>UOM</th> </tr> </thead> <tbody> <tr> <td>VM2009A0</td> <td>D16 SILVER ELLIPTICAL SUPPORT</td> <td>1.000</td> <td>PC</td> </tr> </tbody> </table>  | Code | Description | Qty                                  | UOM   | VM2009A0 | D16 SILVER ELLIPTICAL SUPPORT | 1.000                            | PC    |          |                                |                                      |       |          |                |                               |       |          |              |       |    |
|           |                                      |  | Code       | Description                           | Qty   | UOM  |             |                                      |       |          |                               |                                  |       |          |                                |                                      |       |          |                |                               |       |          |              |       |    |
| VM2009A0  | D16 SILVER ELLIPTICAL SUPPORT        | 1.000  | PC         |                                       |   |      |             |                                      |       |          |                               |                                  |       |          |                                |                                      |       |          |                |                               |       |          |              |       |    |
| KVM1019B  | MANUAL PROVER CONTROL BOARD KIT      | <table border="1"> <thead> <tr> <th>Code</th> <th>Description</th> <th>Qty</th> <th>UOM</th> </tr> </thead> <tbody> <tr> <td>MS1018B0</td> <td>MANUAL PROOVER CONTROL BOARD STICKER</td> <td>1.000</td> <td>PC</td> </tr> <tr> <td>MS1018C0</td> <td>MANUAL PROOVER FRONT COVER (° C)</td> <td>1.000</td> <td>PC</td> </tr> <tr> <td>VM1019B0</td> <td>MANUAL PROOVER PLASTIC CONTROL PANEL</td> <td>1.000</td> <td>PC</td> </tr> <tr> <td>VM2009A0</td> <td>D16 SILVER ELLIPTICAL SUPPORT</td> <td>3.000</td> <td>PC</td> </tr> </tbody> </table> | Code       | Description                           | Qty   | UOM  | MS1018B0    | MANUAL PROOVER CONTROL BOARD STICKER | 1.000 | PC       | MS1018C0                      | MANUAL PROOVER FRONT COVER (° C) | 1.000 | PC       | VM1019B0                       | MANUAL PROOVER PLASTIC CONTROL PANEL | 1.000 | PC       | VM2009A0       | D16 SILVER ELLIPTICAL SUPPORT | 3.000 | PC       |              |       |    |
| Code      | Description                          | Qty  | UOM        |                                       |   |      |             |                                      |       |          |                               |                                  |       |          |                                |                                      |       |          |                |                               |       |          |              |       |    |
| MS1018B0  | MANUAL PROOVER CONTROL BOARD STICKER | 1.000  | PC         |                                       |   |      |             |                                      |       |          |                               |                                  |       |          |                                |                                      |       |          |                |                               |       |          |              |       |    |
| MS1018C0  | MANUAL PROOVER FRONT COVER (° C)     | 1.000  | PC         |                                       |   |      |             |                                      |       |          |                               |                                  |       |          |                                |                                      |       |          |                |                               |       |          |              |       |    |
| VM1019B0  | MANUAL PROOVER PLASTIC CONTROL PANEL | 1.000  | PC         |                                       |   |      |             |                                      |       |          |                               |                                  |       |          |                                |                                      |       |          |                |                               |       |          |              |       |    |
| VM2009A0  | D16 SILVER ELLIPTICAL SUPPORT        | 3.000  | PC         |                                       |   |      |             |                                      |       |          |                               |                                  |       |          |                                |                                      |       |          |                |                               |       |          |              |       |    |
| MN1120A   | MN1120A0                             |   | KMN1120A   | LMICRO 0-60 MIN TIMER KNOB KIT        | <table border="1"> <thead> <tr> <th>Code</th> <th>Description</th> <th>Qty</th> <th>UOM</th> </tr> </thead> <tbody> <tr> <td>MN1120A0</td> <td>MN1120A0</td> <td>1.000</td> <td>PC</td> </tr> </tbody> </table>   | Code | Description | Qty                                  | UOM   | MN1120A0 | MN1120A0                      | 1.000                            | PC    |          |                                |                                      |       |          |                |                               |       |          |              |       |    |
| Code      | Description                          | Qty  | UOM        |                                       |   |      |             |                                      |       |          |                               |                                  |       |          |                                |                                      |       |          |                |                               |       |          |              |       |    |
| MN1120A0  | MN1120A0                             | 1.000  | PC         |                                       |   |      |             |                                      |       |          |                               |                                  |       |          |                                |                                      |       |          |                |                               |       |          |              |       |    |
| MN1122A   | MN1122A0                             |   | KMN1122A   | LMICRO 175-500°F TEMPERATURE KNOB KIT | <table border="1"> <thead> <tr> <th>Code</th> <th>Description</th> <th>Qty</th> <th>UOM</th> </tr> </thead> <tbody> <tr> <td>MN1122A0</td> <td>MN1122A0</td> <td>1.000</td> <td>PC</td> </tr> </tbody> </table>   | Code | Description | Qty                                  | UOM   | MN1122A0 | MN1122A0                      | 1.000                            | PC    |          |                                |                                      |       |          |                |                               |       |          |              |       |    |
| Code      | Description                          | Qty  | UOM        |                                       |   |      |             |                                      |       |          |                               |                                  |       |          |                                |                                      |       |          |                |                               |       |          |              |       |    |
| MN1122A0  | MN1122A0                             | 1.000  | PC         |                                       |   |      |             |                                      |       |          |                               |                                  |       |          |                                |                                      |       |          |                |                               |       |          |              |       |    |
| TM1001C   | 15 SEC 120/240V BUZZER KIT           |   | KTM1001C   | 15 SEC BUZZER KIT                     | <table border="1"> <thead> <tr> <th>Code</th> <th>Description</th> <th>Qty</th> <th>UOM</th> </tr> </thead> <tbody> <tr> <td>TM1001C3</td> <td>15 SEC 120/240V BUZZER KIT</td> <td>1.000</td> <td>PC</td> </tr> <tr> <td>VI1220A1</td> <td>4,2x12 TCB SELF-TAPPIN G SCREW</td> <td>3.000</td> <td>PC</td> </tr> <tr> <td>VI1850A0</td> <td>TCB M4x6 SCREW</td> <td>3.000</td> <td>PC</td> </tr> <tr> <td>VM1745A0</td> <td>CARD SUPPORT</td> <td>3.000</td> <td>PC</td> </tr> </tbody> </table> | Code | Description | Qty                                  | UOM   | TM1001C3 | 15 SEC 120/240V BUZZER KIT    | 1.000                            | PC    | VI1220A1 | 4,2x12 TCB SELF-TAPPIN G SCREW | 3.000                                | PC    | VI1850A0 | TCB M4x6 SCREW | 3.000                         | PC    | VM1745A0 | CARD SUPPORT | 3.000 | PC |
|           |                                      |  | Code       | Description                           | Qty   | UOM  |             |                                      |       |          |                               |                                  |       |          |                                |                                      |       |          |                |                               |       |          |              |       |    |
|           |                                      |  | TM1001C3   | 15 SEC 120/240V BUZZER KIT            | 1.000   | PC   |             |                                      |       |          |                               |                                  |       |          |                                |                                      |       |          |                |                               |       |          |              |       |    |
|           |                                      |  | VI1220A1   | 4,2x12 TCB SELF-TAPPIN G SCREW        | 3.000   | PC   |             |                                      |       |          |                               |                                  |       |          |                                |                                      |       |          |                |                               |       |          |              |       |    |
| VI1850A0  | TCB M4x6 SCREW                       | 3.000  | PC         |                                       |   |      |             |                                      |       |          |                               |                                  |       |          |                                |                                      |       |          |                |                               |       |          |              |       |    |
| VM1745A0  | CARD SUPPORT                         | 3.000  | PC         |                                       |   |      |             |                                      |       |          |                               |                                  |       |          |                                |                                      |       |          |                |                               |       |          |              |       |    |

| COMPONENT |   |   | SPARE PART |  |  |  |  |      |             |          |   |          |                             |          |                                    |          |                                    |          |                |          |                |          |                                |          |                                |          |                       |       |    |          |                    |       |    |          |                               |       |    |
|-----------|---|---|------------|--|--|--|--|------|-------------|----------|---|----------|-----------------------------|----------|------------------------------------|----------|------------------------------------|----------|----------------|----------|----------------|----------|--------------------------------|----------|--------------------------------|----------|-----------------------|-------|----|----------|--------------------|-------|----|----------|-------------------------------|-------|----|
| Code      | Description                                   | Image   | Code       | Description                                  | Kit components   |  |  |      |             |          |   |          |                             |          |                                    |          |                                    |          |                |          |                |          |                                |          |                                |          |                       |       |    |          |                    |       |    |          |                               |       |    |
| TM1005A   | MI2 60 MIN 250V<br>16A TIMER                  |    | KTM1005A   | 60 MIN TIMER KIT                             | <table border="1"> <thead> <tr> <th>Code</th> <th>Description</th> <th>Qty</th> <th>UOM</th> </tr> </thead> <tbody> <tr> <td>TM1005A0</td> <td>MI2 60 MIN 250V 16A TIME</td> <td>1.000</td> <td>PC</td> </tr> <tr> <td>VI1850A0</td> <td>TCB M4x6 SCREW</td> <td>2.000</td> <td>PC</td> </tr> </tbody> </table>  | Code                                     | Description  | Qty  | UOM         | TM1005A0 | MI2 60 MIN 250V 16A TIME                | 1.000    | PC                          | VI1850A0 | TCB M4x6 SCREW                     | 2.000    | PC                                 |          |                |          |                |          |                                |          |                                |          |                       |       |    |          |                    |       |    |          |                               |       |    |
|           |   |   |            |  | Code   | Description                              | Qty  | UOM  |             |          |   |          |                             |          |                                    |          |                                    |          |                |          |                |          |                                |          |                                |          |                       |       |    |          |                    |       |    |          |                               |       |    |
| TM1005A0  | MI2 60 MIN 250V 16A TIME                      | 1.000   | PC         |  |  |  |  |      |             |          |   |          |                             |          |                                    |          |                                    |          |                |          |                |          |                                |          |                                |          |                       |       |    |          |                    |       |    |          |                               |       |    |
| VI1850A0  | TCB M4x6 SCREW                                | 2.000   | PC         |  |  |  |  |      |             |          |   |          |                             |          |                                    |          |                                    |          |                |          |                |          |                                |          |                                |          |                       |       |    |          |                    |       |    |          |                               |       |    |
| TR1100A   | 269°C 55.19052.80<br>ADJUSTABLE<br>THERMOSTAT |    | KTR1100A   | 269°C<br>THERMOSTAT KIT                      | <table border="1"> <thead> <tr> <th>Code</th> <th>Description</th> <th>Qty</th> <th>UOM</th> </tr> </thead> <tbody> <tr> <td>TR1100A0</td> <td>269°C 55.19052.80 ADJUSTABLE THERMOSTAT</td> <td>1.000</td> <td>PC</td> </tr> <tr> <td>VI1850A0</td> <td>TCB M4x6 SCREW</td> <td>2.000</td> <td>PC</td> </tr> </tbody> </table>   | Code                                     | Description  | Qty  | UOM         | TR1100A0 | 269°C 55.19052.80 ADJUSTABLE THERMOSTAT | 1.000    | PC                          | VI1850A0 | TCB M4x6 SCREW                     | 2.000    | PC                                 |          |                |          |                |          |                                |          |                                |          |                       |       |    |          |                    |       |    |          |                               |       |    |
| Code      | Description                                   | Qty   | UOM        |  |  |  |  |      |             |          |   |          |                             |          |                                    |          |                                    |          |                |          |                |          |                                |          |                                |          |                       |       |    |          |                    |       |    |          |                               |       |    |
| TR1100A0  | 269°C 55.19052.80 ADJUSTABLE THERMOSTAT       | 1.000   | PC         |  |  |  |  |      |             |          |   |          |                             |          |                                    |          |                                    |          |                |          |                |          |                                |          |                                |          |                       |       |    |          |                    |       |    |          |                               |       |    |
| VI1850A0  | TCB M4x6 SCREW                                | 2.000   | PC         |  |  |  |  |      |             |          |   |          |                             |          |                                    |          |                                    |          |                |          |                |          |                                |          |                                |          |                       |       |    |          |                    |       |    |          |                               |       |    |
| VM1385B   | LCM 480 CONTROL<br>PANEL                      |  | KVM1416B   | CALDOBAKE SF003<br>COMPLETE<br>CONTROL BOARD | <table border="1"> <thead> <tr> <th>Code</th> <th>Description</th> <th>Qty</th> <th>UOM</th> </tr> </thead> <tbody> <tr> <td>IE1905A0</td> <td>FC-650-FMC AWG18 WHITE WIRE</td> <td>2.000</td> <td>PC</td> </tr> <tr> <td>VE1530A0</td> <td>GOLD THERMOMETE R BLUE LIGHT COVER</td> <td>1.000</td> <td>PC</td> </tr> <tr> <td>VE1535A1</td> <td>230V WHITE LED</td> <td>1.000</td> <td>PC</td> </tr> <tr> <td>VI1220A1</td> <td>4,2x12 TCB SELF-TAPPIN G SCREW</td> <td>3.000</td> <td>PC</td> </tr> <tr> <td>VM1385B1</td> <td>LCM 480 CONTROL PANEL</td> <td>1.000</td> <td>PC</td> </tr> <tr> <td>VM1782A0</td> <td>INNER LAMP SUPPORT</td> <td>1.000</td> <td>PC</td> </tr> <tr> <td>VM2009A0</td> <td>D16 SILVER ELLIPTICAL SUPPORT</td> <td>1.000</td> <td>PC</td> </tr> </tbody> </table> | Code                                     | Description  | Qty  | UOM         | IE1905A0 | FC-650-FMC AWG18 WHITE WIRE             | 2.000    | PC                          | VE1530A0 | GOLD THERMOMETE R BLUE LIGHT COVER | 1.000    | PC                                 | VE1535A1 | 230V WHITE LED | 1.000    | PC             | VI1220A1 | 4,2x12 TCB SELF-TAPPIN G SCREW | 3.000    | PC                             | VM1385B1 | LCM 480 CONTROL PANEL | 1.000 | PC | VM1782A0 | INNER LAMP SUPPORT | 1.000 | PC | VM2009A0 | D16 SILVER ELLIPTICAL SUPPORT | 1.000 | PC |
|           |   |   |            |  | Code   | Description                              | Qty  | UOM  |             |          |   |          |                             |          |                                    |          |                                    |          |                |          |                |          |                                |          |                                |          |                       |       |    |          |                    |       |    |          |                               |       |    |
|           |   |   |            |  | IE1905A0   | FC-650-FMC AWG18 WHITE WIRE              | 2.000  | PC   |             |          |   |          |                             |          |                                    |          |                                    |          |                |          |                |          |                                |          |                                |          |                       |       |    |          |                    |       |    |          |                               |       |    |
|           |   |   |            |  | VE1530A0   | GOLD THERMOMETE R BLUE LIGHT COVER       | 1.000  | PC   |             |          |   |          |                             |          |                                    |          |                                    |          |                |          |                |          |                                |          |                                |          |                       |       |    |          |                    |       |    |          |                               |       |    |
|           |   |   |            |  | VE1535A1   | 230V WHITE LED                           | 1.000  | PC   |             |          |   |          |                             |          |                                    |          |                                    |          |                |          |                |          |                                |          |                                |          |                       |       |    |          |                    |       |    |          |                               |       |    |
|           |   |   |            |  | VI1220A1   | 4,2x12 TCB SELF-TAPPIN G SCREW           | 3.000  | PC   |             |          |   |          |                             |          |                                    |          |                                    |          |                |          |                |          |                                |          |                                |          |                       |       |    |          |                    |       |    |          |                               |       |    |
|           |   |   |            |  | VM1385B1   | LCM 480 CONTROL PANEL                    | 1.000  | PC   |             |          |   |          |                             |          |                                    |          |                                    |          |                |          |                |          |                                |          |                                |          |                       |       |    |          |                    |       |    |          |                               |       |    |
|           |   |   |            |  | VM1782A0   | INNER LAMP SUPPORT                       | 1.000  | PC   |             |          |   |          |                             |          |                                    |          |                                    |          |                |          |                |          |                                |          |                                |          |                       |       |    |          |                    |       |    |          |                               |       |    |
|           |   |   |            |  | VM2009A0   | D16 SILVER ELLIPTICAL SUPPORT            | 1.000  | PC   |             |          |   |          |                             |          |                                    |          |                                    |          |                |          |                |          |                                |          |                                |          |                       |       |    |          |                    |       |    |          |                               |       |    |
|           |   |   |            |  | KVM1385B   | LINEMICRO<br>ROBERTA<br>CONTROL PANEL KI | <table border="1"> <thead> <tr> <th>Code</th> <th>Description</th> <th>Qty</th> <th>UOM</th> </tr> </thead> <tbody> <tr> <td>IE1905A0</td> <td>FC-650-FMC AWG18 WHITE WIRE</td> <td>2.000</td> <td>PC</td> </tr> <tr> <td>VE1530A0</td> <td>GOLD THERMOMETE R BLUE LIGHT COVER</td> <td>1.000</td> <td>PC</td> </tr> <tr> <td>VE1535A1</td> <td>230V WHITE LED</td> <td>1.000</td> <td>PC</td> </tr> <tr> <td>VI1220A1</td> <td>4,2x12 TCB SELF-TAPPIN G SCREW</td> <td>3.000</td> <td>PC</td> </tr> </tbody> </table> | Code | Description | Qty      | UOM                                     | IE1905A0 | FC-650-FMC AWG18 WHITE WIRE | 2.000    | PC                                 | VE1530A0 | GOLD THERMOMETE R BLUE LIGHT COVER | 1.000    | PC             | VE1535A1 | 230V WHITE LED | 1.000    | PC                             | VI1220A1 | 4,2x12 TCB SELF-TAPPIN G SCREW | 3.000    | PC                    |       |    |          |                    |       |    |          |                               |       |    |
| Code      | Description                                   | Qty   | UOM        |  |  |  |  |      |             |          |   |          |                             |          |                                    |          |                                    |          |                |          |                |          |                                |          |                                |          |                       |       |    |          |                    |       |    |          |                               |       |    |
| IE1905A0  | FC-650-FMC AWG18 WHITE WIRE                   | 2.000   | PC         |  |  |  |  |      |             |          |   |          |                             |          |                                    |          |                                    |          |                |          |                |          |                                |          |                                |          |                       |       |    |          |                    |       |    |          |                               |       |    |
| VE1530A0  | GOLD THERMOMETE R BLUE LIGHT COVER            | 1.000   | PC         |  |  |  |  |      |             |          |   |          |                             |          |                                    |          |                                    |          |                |          |                |          |                                |          |                                |          |                       |       |    |          |                    |       |    |          |                               |       |    |
| VE1535A1  | 230V WHITE LED                                | 1.000   | PC         |  |  |  |  |      |             |          |   |          |                             |          |                                    |          |                                    |          |                |          |                |          |                                |          |                                |          |                       |       |    |          |                    |       |    |          |                               |       |    |
| VI1220A1  | 4,2x12 TCB SELF-TAPPIN G SCREW                | 3.000   | PC         |  |  |  |  |      |             |          |   |          |                             |          |                                    |          |                                    |          |                |          |                |          |                                |          |                                |          |                       |       |    |          |                    |       |    |          |                               |       |    |

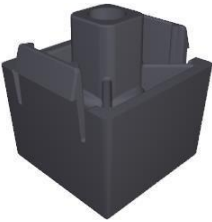

| COMPONENT |  |   | SPARE PART |  |   |      |             |     |     |          |  |       |    |          |                         |       |    |          |                               |       |    |
|-----------|--|---|------------|--|---|------|-------------|-----|-----|----------|--|-------|----|----------|-------------------------|-------|----|----------|-------------------------------|-------|----|
| Code      | Description                            | Image   | Code       | Description                            | Kit components  |      |             |     |     |          |  |       |    |          |                         |       |    |          |                               |       |    |
| VM1385B   | LCM 480 CONTROL PANEL                  |    | KVM1385B   | LINEMICRO ROBERTA CONTROL PANEL KI     | <table border="1"> <thead> <tr> <th>Code</th> <th>Description</th> <th>Qty</th> <th>UOM</th> </tr> </thead> <tbody> <tr> <td>VM1385B1</td> <td>LCM 480 CONTROL PANEL</td> <td>1.000</td> <td>PC</td> </tr> <tr> <td>VM1762A0</td> <td>INNER LAMP SUPPORT</td> <td>1.000</td> <td>PC</td> </tr> <tr> <td>VM2009A0</td> <td>D16 SILVER ELLIPTICAL SUPPORT</td> <td>1.000</td> <td>PC</td> </tr> </tbody> </table> | Code | Description | Qty | UOM | VM1385B1 | LCM 480 CONTROL PANEL                  | 1.000 | PC | VM1762A0 | INNER LAMP SUPPORT      | 1.000 | PC | VM2009A0 | D16 SILVER ELLIPTICAL SUPPORT | 1.000 | PC |
| Code      | Description                            | Qty   | UOM        |  |   |      |             |     |     |          |  |       |    |          |                         |       |    |          |                               |       |    |
| VM1385B1  | LCM 480 CONTROL PANEL                  | 1.000   | PC         |  |   |      |             |     |     |          |  |       |    |          |                         |       |    |          |                               |       |    |
| VM1762A0  | INNER LAMP SUPPORT                     | 1.000   | PC         |  |   |      |             |     |     |          |  |       |    |          |                         |       |    |          |                               |       |    |
| VM2009A0  | D16 SILVER ELLIPTICAL SUPPORT          | 1.000   | PC         |  |   |      |             |     |     |          |  |       |    |          |                         |       |    |          |                               |       |    |
| VM1750A   | BRASS COMB CLAM                        |   | KVM1750A   | COMB TERMINAL BLOCK KIT                | <table border="1"> <thead> <tr> <th>Code</th> <th>Description</th> <th>Qty</th> <th>UOM</th> </tr> </thead> <tbody> <tr> <td>V11040A0</td> <td>INDENTED INTERNAL WASHER D=6 ZN</td> <td>2.000</td> <td>PC</td> </tr> <tr> <td>VM1750A0</td> <td>BRASS COMB CLAMP</td> <td>1.000</td> <td>PC</td> </tr> </tbody> </table>  | Code | Description | Qty | UOM | V11040A0 | INDENTED INTERNAL WASHER D=6 ZN        | 2.000 | PC | VM1750A0 | BRASS COMB CLAMP        | 1.000 | PC |          |                               |       |    |
| Code      | Description                            | Qty   | UOM        |  |   |      |             |     |     |          |  |       |    |          |                         |       |    |          |                               |       |    |
| V11040A0  | INDENTED INTERNAL WASHER D=6 ZN        | 2.000   | PC         |  |   |      |             |     |     |          |  |       |    |          |                         |       |    |          |                               |       |    |
| VM1750A0  | BRASS COMB CLAMP                       | 1.000   | PC         |  |   |      |             |     |     |          |  |       |    |          |                         |       |    |          |                               |       |    |
| ASM2314A  | Door seal                              |  | ASM2314A0  | Door seal                              |   |      |             |     |     |          |  |       |    |          |                         |       |    |          |                               |       |    |
| CR1070A   | HINGE LATCH L. C.                      |  | KCR1070A   | LM HINGES LATCH 2 PCS. KIT             | <table border="1"> <thead> <tr> <th>Code</th> <th>Description</th> <th>Qty</th> <th>UOM</th> </tr> </thead> <tbody> <tr> <td>CR1070A0</td> <td>HINGE LATCH L. C.</td> <td>2.000</td> <td>PC</td> </tr> <tr> <td>V11875A0</td> <td>SCREW M5X10 TC1/2T INOX</td> <td>4.000</td> <td>PC</td> </tr> </tbody> </table>   | Code | Description | Qty | UOM | CR1070A0 | HINGE LATCH L. C.                      | 2.000 | PC | V11875A0 | SCREW M5X10 TC1/2T INOX | 4.000 | PC |          |                               |       |    |
| Code      | Description                            | Qty   | UOM        |  |   |      |             |     |     |          |  |       |    |          |                         |       |    |          |                               |       |    |
| CR1070A0  | HINGE LATCH L. C.                      | 2.000   | PC         |  |   |      |             |     |     |          |  |       |    |          |                         |       |    |          |                               |       |    |
| V11875A0  | SCREW M5X10 TC1/2T INOX                | 4.000   | PC         |  |   |      |             |     |     |          |  |       |    |          |                         |       |    |          |                               |       |    |
| MR1001A   | SJTO CABLE AWG14X3 NEMA PLUG 5-15P 15A |  | KMR1001A   | CABLE SJTO AWG14X3 ENCH.NEMA 5-15P 15A | <table border="1"> <thead> <tr> <th>Code</th> <th>Description</th> <th>Qty</th> <th>UOM</th> </tr> </thead> <tbody> <tr> <td>MR1001A0</td> <td>SJTO CABLE AWG14X3 NEMA PLUG 5-15P 15A</td> <td>1.000</td> <td>PC</td> </tr> </tbody> </table>   | Code | Description | Qty | UOM | MR1001A0 | SJTO CABLE AWG14X3 NEMA PLUG 5-15P 15A | 1.000 | PC |          |                         |       |    |          |                               |       |    |
| Code      | Description                            | Qty   | UOM        |  |   |      |             |     |     |          |  |       |    |          |                         |       |    |          |                               |       |    |
| MR1001A0  | SJTO CABLE AWG14X3 NEMA PLUG 5-15P 15A | 1.000   | PC         |  |   |      |             |     |     |          |  |       |    |          |                         |       |    |          |                               |       |    |

| COMPONENT |                                       |   | SPARE PART               |  |   |      |             |     |     |          |                                    |       |    |          |                                 |       |    |          |                                     |       |     |          |                                       |       |    |          |                               |       |    |
|-----------|---------------------------------------|---|--------------------------|--|---|------|-------------|-----|-----|----------|------------------------------------|-------|----|----------|---------------------------------|-------|----|----------|-------------------------------------|-------|-----|----------|---------------------------------------|-------|----|----------|-------------------------------|-------|----|
| Code      | Description                           | Image   | Code                     | Description  | Kit components  |      |             |     |     |          |                                    |       |    |          |                                 |       |    |          |                                     |       |     |          |                                       |       |    |          |                               |       |    |
| PD1001A   | 35x35 H26 GREY PLASTIC+RUBBER FOOT    |    | KPD1001A                 | 35x35 H26 FEET 4 PCS KIT   | <table border="1"> <thead> <tr> <th>Code</th> <th>Description</th> <th>Qty</th> <th>UOM</th> </tr> </thead> <tbody> <tr> <td>PD1001A0</td> <td>35x35 H26 GREY PLASTIC+RUBBER FOOT</td> <td>4.000</td> <td>PC</td> </tr> </tbody> </table>   | Code | Description | Qty | UOM | PD1001A0 | 35x35 H26 GREY PLASTIC+RUBBER FOOT | 4.000 | PC |          |                                 |       |    |          |                                     |       |     |          |                                       |       |    |          |                               |       |    |
| Code      | Description                           | Qty   | UOM                      |  |   |      |             |     |     |          |                                    |       |    |          |                                 |       |    |          |                                     |       |     |          |                                       |       |    |          |                               |       |    |
| PD1001A0  | 35x35 H26 GREY PLASTIC+RUBBER FOOT    | 4.000   | PC                       |  |   |      |             |     |     |          |                                    |       |    |          |                                 |       |    |          |                                     |       |     |          |                                       |       |    |          |                               |       |    |
| TR1136A   | 318°C -0/+24 1 POLE SAFETY THERMOSTAT |    | KTR1136A                 | 318°C -0/+24 SAFETY THERMOSTAT KIT   | <table border="1"> <thead> <tr> <th>Code</th> <th>Description</th> <th>Qty</th> <th>UOM</th> </tr> </thead> <tbody> <tr> <td>0H7030A0</td> <td>THERMOSTAT BULB INLET COVER</td> <td>1.000</td> <td>PC</td> </tr> <tr> <td>GN1531A0</td> <td>THERMOSTAT BULB INLET SEALING</td> <td>1.000</td> <td>PC</td> </tr> <tr> <td>SL1045A0</td> <td>S57 BLACK SILICONE - 80ml CARTRIDGE</td> <td>1.000</td> <td>PC</td> </tr> <tr> <td>TR1136A0</td> <td>318°C -0/+24 1 POLE SAFETY THERMOSTAT</td> <td>1.000</td> <td>PC</td> </tr> <tr> <td>VI1220A1</td> <td>4,2x12 TCB SELF-TAPPING SCREW</td> <td>3.000</td> <td>PC</td> </tr> </tbody> </table>          | Code | Description | Qty | UOM | 0H7030A0 | THERMOSTAT BULB INLET COVER        | 1.000 | PC | GN1531A0 | THERMOSTAT BULB INLET SEALING   | 1.000 | PC | SL1045A0 | S57 BLACK SILICONE - 80ml CARTRIDGE | 1.000 | PC  | TR1136A0 | 318°C -0/+24 1 POLE SAFETY THERMOSTAT | 1.000 | PC | VI1220A1 | 4,2x12 TCB SELF-TAPPING SCREW | 3.000 | PC |
| Code      | Description                           | Qty   | UOM                      |  |   |      |             |     |     |          |                                    |       |    |          |                                 |       |    |          |                                     |       |     |          |                                       |       |    |          |                               |       |    |
| 0H7030A0  | THERMOSTAT BULB INLET COVER           | 1.000   | PC                       |  |   |      |             |     |     |          |                                    |       |    |          |                                 |       |    |          |                                     |       |     |          |                                       |       |    |          |                               |       |    |
| GN1531A0  | THERMOSTAT BULB INLET SEALING         | 1.000   | PC                       |  |   |      |             |     |     |          |                                    |       |    |          |                                 |       |    |          |                                     |       |     |          |                                       |       |    |          |                               |       |    |
| SL1045A0  | S57 BLACK SILICONE - 80ml CARTRIDGE   | 1.000   | PC                       |  |   |      |             |     |     |          |                                    |       |    |          |                                 |       |    |          |                                     |       |     |          |                                       |       |    |          |                               |       |    |
| TR1136A0  | 318°C -0/+24 1 POLE SAFETY THERMOSTAT | 1.000   | PC                       |  |   |      |             |     |     |          |                                    |       |    |          |                                 |       |    |          |                                     |       |     |          |                                       |       |    |          |                               |       |    |
| VI1220A1  | 4,2x12 TCB SELF-TAPPING SCREW         | 3.000   | PC                       |  |   |      |             |     |     |          |                                    |       |    |          |                                 |       |    |          |                                     |       |     |          |                                       |       |    |          |                               |       |    |
| VE1150A   | CAPACITOR 10 µF 240 Vac 50/60         |  | KVE1150A                 | 10 µF 240 Vac 50/60 CAPACITOR KIT  | <table border="1"> <thead> <tr> <th>Code</th> <th>Description</th> <th>Qty</th> <th>UOM</th> </tr> </thead> <tbody> <tr> <td>VE1150A0</td> <td>CAPACITOR 10 µF 240 Vac 50/60</td> <td>1.000</td> <td>PC</td> </tr> <tr> <td>VI1931A0</td> <td>M6x1.65 H4 CH13 ZINC PLATED NUT</td> <td>1.000</td> <td>PC</td> </tr> <tr> <td>VI1932A0</td> <td>D8 INDENTED ZINC PLATED WASHER</td> <td>1.000</td> <td>PC</td> </tr> </tbody> </table>   | Code | Description | Qty | UOM | VE1150A0 | CAPACITOR 10 µF 240 Vac 50/60      | 1.000 | PC | VI1931A0 | M6x1.65 H4 CH13 ZINC PLATED NUT | 1.000 | PC | VI1932A0 | D8 INDENTED ZINC PLATED WASHER      | 1.000 | PC  |          |                                       |       |    |          |                               |       |    |
| Code      | Description                           | Qty   | UOM                      |  |   |      |             |     |     |          |                                    |       |    |          |                                 |       |    |          |                                     |       |     |          |                                       |       |    |          |                               |       |    |
| VE1150A0  | CAPACITOR 10 µF 240 Vac 50/60         | 1.000   | PC                       |  |   |      |             |     |     |          |                                    |       |    |          |                                 |       |    |          |                                     |       |     |          |                                       |       |    |          |                               |       |    |
| VI1931A0  | M6x1.65 H4 CH13 ZINC PLATED NUT       | 1.000   | PC                       |  |   |      |             |     |     |          |                                    |       |    |          |                                 |       |    |          |                                     |       |     |          |                                       |       |    |          |                               |       |    |
| VI1932A0  | D8 INDENTED ZINC PLATED WASHER        | 1.000   | PC                       |  |   |      |             |     |     |          |                                    |       |    |          |                                 |       |    |          |                                     |       |     |          |                                       |       |    |          |                               |       |    |
| VM1950A   | WATER PROTECTION DRIP FLAP            |  | KVM1950A<br><br>KVM0003A | LISA BACK PLASTIC DRIP FLAP KIT<br><br>DOMENICA BACK PLASTIC DRIP FLAP KIT | <table border="1"> <thead> <tr> <th>Code</th> <th>Description</th> <th>Qty</th> <th>UOM</th> </tr> </thead> <tbody> <tr> <td>0F1421A1</td> <td>LISA EXTERNAL BACK PANEL</td> <td>1.000</td> <td>PC</td> </tr> <tr> <td>VM1950A2</td> <td>WATER PROTECTION DRIP FLAP</td> <td>1.000</td> <td>PC</td> </tr> </tbody> </table><br><table border="1"> <thead> <tr> <th>Code</th> <th>Description</th> <th>Qty</th> <th>UOM</th> </tr> </thead> <tbody> <tr> <td>0F1429A1</td> <td>XF043-ES BACK PANEL</td> <td>1.000</td> <td>PC</td> </tr> <tr> <td>VM1950A2</td> <td>WATER PROTECTION DRIP FLAP</td> <td>1.000</td> <td>PC</td> </tr> </tbody> </table> | Code | Description | Qty | UOM | 0F1421A1 | LISA EXTERNAL BACK PANEL           | 1.000 | PC | VM1950A2 | WATER PROTECTION DRIP FLAP      | 1.000 | PC | Code     | Description                         | Qty   | UOM | 0F1429A1 | XF043-ES BACK PANEL                   | 1.000 | PC | VM1950A2 | WATER PROTECTION DRIP FLAP    | 1.000 | PC |
| Code      | Description                           | Qty   | UOM                      |  |   |      |             |     |     |          |                                    |       |    |          |                                 |       |    |          |                                     |       |     |          |                                       |       |    |          |                               |       |    |
| 0F1421A1  | LISA EXTERNAL BACK PANEL              | 1.000   | PC                       |  |   |      |             |     |     |          |                                    |       |    |          |                                 |       |    |          |                                     |       |     |          |                                       |       |    |          |                               |       |    |
| VM1950A2  | WATER PROTECTION DRIP FLAP            | 1.000   | PC                       |  |   |      |             |     |     |          |                                    |       |    |          |                                 |       |    |          |                                     |       |     |          |                                       |       |    |          |                               |       |    |
| Code      | Description                           | Qty   | UOM                      |  |   |      |             |     |     |          |                                    |       |    |          |                                 |       |    |          |                                     |       |     |          |                                       |       |    |          |                               |       |    |
| 0F1429A1  | XF043-ES BACK PANEL                   | 1.000   | PC                       |  |   |      |             |     |     |          |                                    |       |    |          |                                 |       |    |          |                                     |       |     |          |                                       |       |    |          |                               |       |    |
| VM1950A2  | WATER PROTECTION DRIP FLAP            | 1.000   | PC                       |  |   |      |             |     |     |          |                                    |       |    |          |                                 |       |    |          |                                     |       |     |          |                                       |       |    |          |                               |       |    |

| COMPONENT |                                    |   | SPARE PART |                                 |  |      |             |                    |       |          |                                |                            |       |          |                            |       |    |
|-----------|------------------------------------|---|------------|---------------------------------|--|------|-------------|--------------------|-------|----------|--------------------------------|----------------------------|-------|----------|----------------------------|-------|----|
| Code      | Description                        | Image   | Code       | Description                     | Kit components   |      |             |                    |       |          |                                |                            |       |          |                            |       |    |
| VM1950A   | WATER PROTECTION DRIP FLAP         |    | KVM0002A   | ANNA BACK PLASTIC DRIP FLAP KIT | <table border="1"> <thead> <tr> <th>Code</th> <th>Description</th> <th>Qty</th> <th>UOM</th> </tr> </thead> <tbody> <tr> <td>0F1422A1</td> <td>LINEMICRO XF023 IP BACK PANEL</td> <td>1.000</td> <td>PC</td> </tr> <tr> <td>VM1950A2</td> <td>WATER PROTECTION DRIP FLAP</td> <td>1.000</td> <td>PC</td> </tr> </tbody> </table> | Code | Description | Qty                | UOM   | 0F1422A1 | LINEMICRO XF023 IP BACK PANEL  | 1.000                      | PC    | VM1950A2 | WATER PROTECTION DRIP FLAP | 1.000 | PC |
|           |                                    |   | Code       | Description                     | Qty  | UOM  |             |                    |       |          |                                |                            |       |          |                            |       |    |
| 0F1422A1  | LINEMICRO XF023 IP BACK PANEL      | 1.000   | PC         |                                 |  |      |             |                    |       |          |                                |                            |       |          |                            |       |    |
| VM1950A2  | WATER PROTECTION DRIP FLAP         | 1.000   | PC         |                                 |  |      |             |                    |       |          |                                |                            |       |          |                            |       |    |
| KVM0001A  | ROBERTA BACK PLASTIC DRIP FLAP KIT | <table border="1"> <thead> <tr> <th>Code</th> <th>Description</th> <th>Qty</th> <th>UOM</th> </tr> </thead> <tbody> <tr> <td>0F1420A1</td> <td>SCHIENA IP ROBERTA</td> <td>1.000</td> <td>PC</td> </tr> <tr> <td>VM1950A2</td> <td>WATER PROTECTION DRIP FLAP</td> <td>1.000</td> <td>PC</td> </tr> </tbody> </table> | Code       | Description                     | Qty  | UOM  | 0F1420A1    | SCHIENA IP ROBERTA | 1.000 | PC       | VM1950A2                       | WATER PROTECTION DRIP FLAP | 1.000 | PC       |                            |       |    |
| Code      | Description                        | Qty   | UOM        |                                 |  |      |             |                    |       |          |                                |                            |       |          |                            |       |    |
| 0F1420A1  | SCHIENA IP ROBERTA                 | 1.000   | PC         |                                 |  |      |             |                    |       |          |                                |                            |       |          |                            |       |    |
| VM1950A2  | WATER PROTECTION DRIP FLAP         | 1.000   | PC         |                                 |  |      |             |                    |       |          |                                |                            |       |          |                            |       |    |
| VM1951A   | CHIMNEY COVER                      |   | KVM1951A   | EXHAUST CHIMNEY COVER KIT       | <table border="1"> <thead> <tr> <th>Code</th> <th>Description</th> <th>Qty</th> <th>UOM</th> </tr> </thead> <tbody> <tr> <td>VI1220A1</td> <td>4,2x12 TCB SELF-TAPPIN G SCREW</td> <td>2.000</td> <td>PC</td> </tr> <tr> <td>VM1951A1</td> <td>CHIMNEY COVER</td> <td>1.000</td> <td>PC</td> </tr> </tbody> </table>             | Code | Description | Qty                | UOM   | VI1220A1 | 4,2x12 TCB SELF-TAPPIN G SCREW | 2.000                      | PC    | VM1951A1 | CHIMNEY COVER              | 1.000 | PC |
| Code      | Description                        | Qty   | UOM        |                                 |  |      |             |                    |       |          |                                |                            |       |          |                            |       |    |
| VI1220A1  | 4,2x12 TCB SELF-TAPPIN G SCREW     | 2.000   | PC         |                                 |  |      |             |                    |       |          |                                |                            |       |          |                            |       |    |
| VM1951A1  | CHIMNEY COVER                      | 1.000   | PC         |                                 |  |      |             |                    |       |          |                                |                            |       |          |                            |       |    |
| VM1952A   | IP MOTOR COVER KI                  |    | KVM1952A   | XF/XFT/XAF/XAFT MOTOR COVER KIT | <table border="1"> <thead> <tr> <th>Code</th> <th>Description</th> <th>Qty</th> <th>UOM</th> </tr> </thead> <tbody> <tr> <td>VI1220A1</td> <td>4,2x12 TCB SELF-TAPPIN G SCREW</td> <td>2.000</td> <td>PC</td> </tr> <tr> <td>VM1952A1</td> <td>IP MOTOR COVER KIT</td> <td>1.000</td> <td>PC</td> </tr> </tbody> </table>        | Code | Description | Qty                | UOM   | VI1220A1 | 4,2x12 TCB SELF-TAPPIN G SCREW | 2.000                      | PC    | VM1952A1 | IP MOTOR COVER KIT         | 1.000 | PC |
| Code      | Description                        | Qty   | UOM        |                                 |  |      |             |                    |       |          |                                |                            |       |          |                            |       |    |
| VI1220A1  | 4,2x12 TCB SELF-TAPPIN G SCREW     | 2.000   | PC         |                                 |  |      |             |                    |       |          |                                |                            |       |          |                            |       |    |
| VM1952A1  | IP MOTOR COVER KIT                 | 1.000   | PC         |                                 |  |      |             |                    |       |          |                                |                            |       |          |                            |       |    |



ASM0313A/0.D01 - ASM0313A0





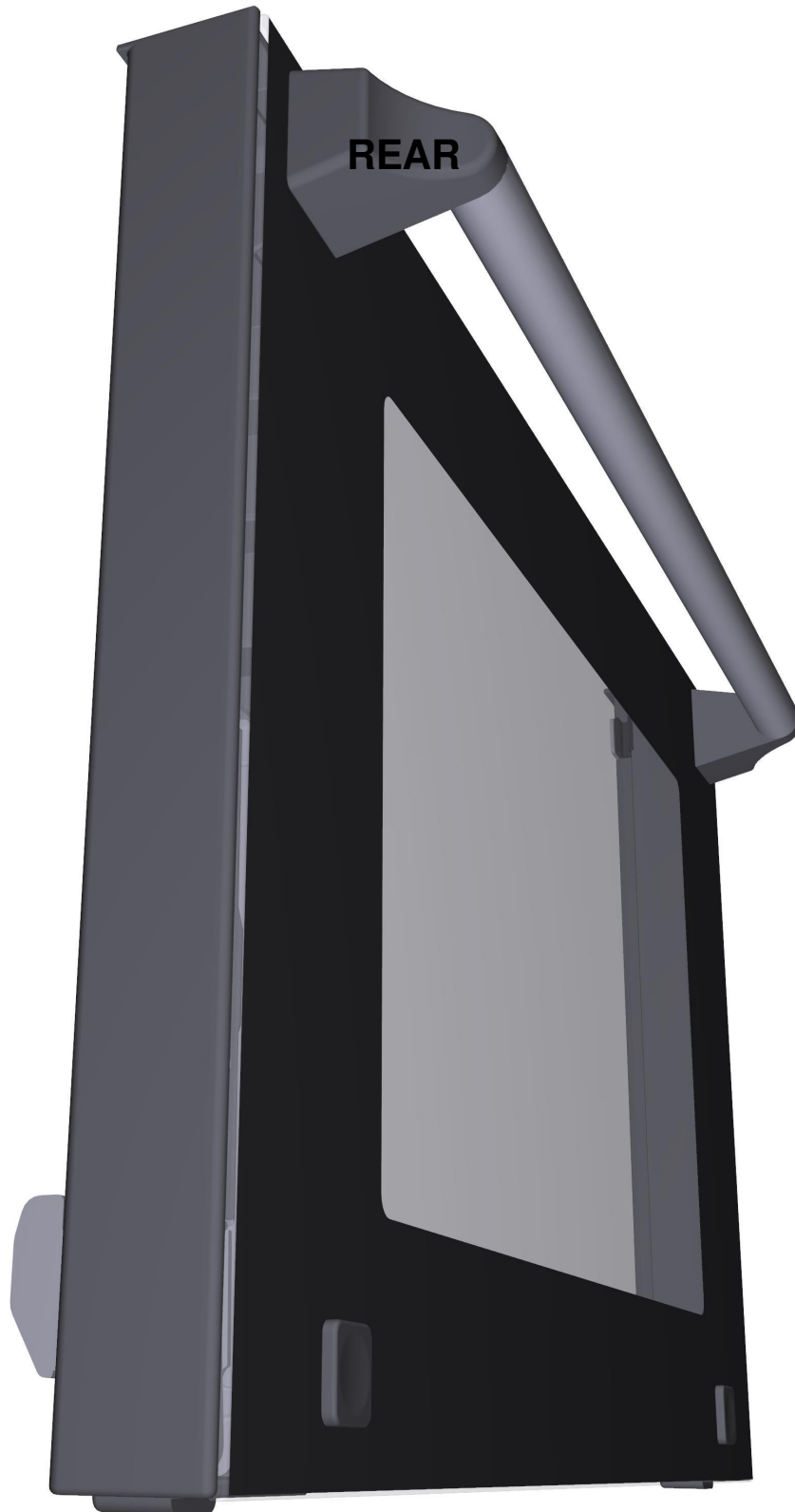

**ASM0313A/0.D01 - ASM0313A0**





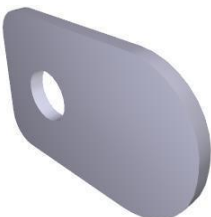

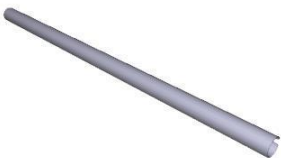

| COMPONENT |  |   | SPARE PART |                                     |  |      |             |     |     |          |                                    |       |    |          |                                    |       |    |          |  |       |    |          |                    |       |    |
|-----------|--|---|------------|-------------------------------------|--|------|-------------|-----|-----|----------|------------------------------------|-------|----|----------|------------------------------------|-------|----|----------|--|-------|----|----------|--------------------|-------|----|
| Code      | Description                            | Image   | Code       | Description                         | Kit components   |      |             |     |     |          |                                    |       |    |          |                                    |       |    |          |  |       |    |          |                    |       |    |
| 0H3110A   | GLASS HOLDING ST. STEEL UPPER PLATE    |    | 0H3110A1   | GLASS HOLDING ST. STEEL UPPER PLATE |  |      |             |     |     |          |                                    |       |    |          |                                    |       |    |          |  |       |    |          |                    |       |    |
| 0H3111A   | GLASS HOLDING ST. STEEL LOWER PLATE    |    | 0H3111A2   | GLASS HOLDING ST. STEEL LOWER PLATE |  |      |             |     |     |          |                                    |       |    |          |                                    |       |    |          |  |       |    |          |                    |       |    |
| CR1055A   | LineMicro ROBERTA DOOR HINGE           |  | KCR1055A   | LineMicro XF003 DOOR HINGES KIT     | <table border="1"> <thead> <tr> <th>Code</th> <th>Description</th> <th>Qty</th> <th>UOM</th> </tr> </thead> <tbody> <tr> <td>CR1055A0</td> <td>LineMicro ROBERTA DOOR HINGE</td> <td>2.000</td> <td>PC</td> </tr> <tr> <td>VI1875A0</td> <td>SCREW M5X10 TC1/2T INOX</td> <td>6.000</td> <td>PC</td> </tr> </tbody> </table>   | Code | Description | Qty | UOM | CR1055A0 | LineMicro ROBERTA DOOR HINGE       | 2.000 | PC | VI1875A0 | SCREW M5X10 TC1/2T INOX            | 6.000 | PC |          |  |       |    |          |                    |       |    |
| Code      | Description                            | Qty   | UOM        |                                     |  |      |             |     |     |          |                                    |       |    |          |                                    |       |    |          |  |       |    |          |                    |       |    |
| CR1055A0  | LineMicro ROBERTA DOOR HINGE           | 2.000   | PC         |                                     |  |      |             |     |     |          |                                    |       |    |          |                                    |       |    |          |  |       |    |          |                    |       |    |
| VI1875A0  | SCREW M5X10 TC1/2T INOX                | 6.000   | PC         |                                     |  |      |             |     |     |          |                                    |       |    |          |                                    |       |    |          |  |       |    |          |                    |       |    |
| 0H3200B   | HANDLE TUBE L = 388 D.18X1             |  | K0H3200B   | LMICRO 480 HANDLE KIT               | <table border="1"> <thead> <tr> <th>Code</th> <th>Description</th> <th>Qty</th> <th>UOM</th> </tr> </thead> <tbody> <tr> <td>0H3200B0</td> <td>HANDLE TUBE L = 388 D.18X1</td> <td>1.000</td> <td>PC</td> </tr> <tr> <td>MG1015B0</td> <td>L.MISS/L.MICR O/CHEFTOP HANDLE END</td> <td>2.000</td> <td>PC</td> </tr> <tr> <td>VI1870A0</td> <td>50x50 SELF-THREADING SCREW FOR PLASTIC</td> <td>2.000</td> <td>PC</td> </tr> </tbody> </table>  | Code | Description | Qty | UOM | 0H3200B0 | HANDLE TUBE L = 388 D.18X1         | 1.000 | PC | MG1015B0 | L.MISS/L.MICR O/CHEFTOP HANDLE END | 2.000 | PC | VI1870A0 | 50x50 SELF-THREADING SCREW FOR PLASTIC | 2.000 | PC |          |                    |       |    |
| Code      | Description                            | Qty   | UOM        |                                     |  |      |             |     |     |          |                                    |       |    |          |                                    |       |    |          |  |       |    |          |                    |       |    |
| 0H3200B0  | HANDLE TUBE L = 388 D.18X1             | 1.000   | PC         |                                     |  |      |             |     |     |          |                                    |       |    |          |                                    |       |    |          |  |       |    |          |                    |       |    |
| MG1015B0  | L.MISS/L.MICR O/CHEFTOP HANDLE END     | 2.000   | PC         |                                     |  |      |             |     |     |          |                                    |       |    |          |                                    |       |    |          |  |       |    |          |                    |       |    |
| VI1870A0  | 50x50 SELF-THREADING SCREW FOR PLASTIC | 2.000   | PC         |                                     |  |      |             |     |     |          |                                    |       |    |          |                                    |       |    |          |  |       |    |          |                    |       |    |
| MG1015B   | L.MISS/L.MICRO/CH EFTOP HANDLE END     |  | KMG1015B   | 2 PCS. HANDLE END KIT               | <table border="1"> <thead> <tr> <th>Code</th> <th>Description</th> <th>Qty</th> <th>UOM</th> </tr> </thead> <tbody> <tr> <td>MG1015B0</td> <td>L.MISS/L.MICR O/CHEFTOP HANDLE END</td> <td>2.000</td> <td>PC</td> </tr> <tr> <td>VI1855A0</td> <td>5X25 SELF-TAPPING SCREW</td> <td>2.000</td> <td>PC</td> </tr> <tr> <td>VI1870A0</td> <td>50x50 SELF-THREADING SCREW FOR PLASTIC</td> <td>2.000</td> <td>PC</td> </tr> <tr> <td>VM1025A0</td> <td>Ø16 GREY NYLON LID</td> <td>2.000</td> <td>PC</td> </tr> </tbody> </table> | Code | Description | Qty | UOM | MG1015B0 | L.MISS/L.MICR O/CHEFTOP HANDLE END | 2.000 | PC | VI1855A0 | 5X25 SELF-TAPPING SCREW            | 2.000 | PC | VI1870A0 | 50x50 SELF-THREADING SCREW FOR PLASTIC | 2.000 | PC | VM1025A0 | Ø16 GREY NYLON LID | 2.000 | PC |
| Code      | Description                            | Qty   | UOM        |                                     |  |      |             |     |     |          |                                    |       |    |          |                                    |       |    |          |  |       |    |          |                    |       |    |
| MG1015B0  | L.MISS/L.MICR O/CHEFTOP HANDLE END     | 2.000   | PC         |                                     |  |      |             |     |     |          |                                    |       |    |          |                                    |       |    |          |  |       |    |          |                    |       |    |
| VI1855A0  | 5X25 SELF-TAPPING SCREW                | 2.000   | PC         |                                     |  |      |             |     |     |          |                                    |       |    |          |                                    |       |    |          |  |       |    |          |                    |       |    |
| VI1870A0  | 50x50 SELF-THREADING SCREW FOR PLASTIC | 2.000   | PC         |                                     |  |      |             |     |     |          |                                    |       |    |          |                                    |       |    |          |  |       |    |          |                    |       |    |
| VM1025A0  | Ø16 GREY NYLON LID                     | 2.000   | PC         |                                     |  |      |             |     |     |          |                                    |       |    |          |                                    |       |    |          |  |       |    |          |                    |       |    |





| COMPONENT |  |   | SPARE PART |  |   |      |             |   |       |          |  |  |       |          |  |  |       |    |
|-----------|--|---|------------|--|---|------|-------------|---|-------|----------|--|--|-------|----------|--|--|-------|----|
| Code      | Description                                      | Image   | Code       | Description  | Kit components  |      |             |   |       |          |  |  |       |          |  |  |       |    |
| GN1240A   | COLUMN-GLASS<br>BLACK SILICON SEA                |    | KVT1190B   | LINEMICRO XF043<br>INTERNAL GLASS KI                 | <table border="1"> <thead> <tr> <th>Code</th> <th>Description</th> <th>Qty</th> <th>UOM</th> </tr> </thead> <tbody> <tr> <td>GN1240A0</td> <td>COLUMN-GLA<br/>SS BLACK<br/>SILICON SEAL</td> <td>4.000</td> <td>PC</td> </tr> <tr> <td>VT1190B0</td> <td>LineMicro<br/>XF043<br/>712x372x4<br/>INTERNAL<br/>GLASS</td> <td>1.000</td> <td>PC</td> </tr> </tbody> </table> | Code | Description | Qty   | UOM   | GN1240A0 | COLUMN-GLA<br>SS BLACK<br>SILICON SEAL | 4.000  | PC    | VT1190B0 | LineMicro<br>XF043<br>712x372x4<br>INTERNAL<br>GLASS | 1.000                                  | PC    |    |
|           |  |   | Code       | Description  | Qty   | UOM  |             |   |       |          |  |  |       |          |  |  |       |    |
|           |  |   | GN1240A0   | COLUMN-GLA<br>SS BLACK<br>SILICON SEAL               | 4.000   | PC   |             |   |       |          |  |  |       |          |  |  |       |    |
|           |  |   | VT1190B0   | LineMicro<br>XF043<br>712x372x4<br>INTERNAL<br>GLASS | 1.000   | PC   |             |   |       |          |  |  |       |          |  |  |       |    |
|           |  |   | KVT1190A   | DOMENICA INT.<br>GLASS KIT VT1190A                   | <table border="1"> <thead> <tr> <th>Code</th> <th>Description</th> <th>Qty</th> <th>UOM</th> </tr> </thead> <tbody> <tr> <td>GN1240A0</td> <td>COLUMN-GLA<br/>SS BLACK<br/>SILICON SEAL</td> <td>4.000</td> <td>PC</td> </tr> <tr> <td>VT1190A0</td> <td></td> <td>1.000</td> <td>PC</td> </tr> </tbody> </table>   | Code | Description | Qty   | UOM   | GN1240A0 | COLUMN-GLA<br>SS BLACK<br>SILICON SEAL | 4.000  | PC    | VT1190A0 |  | 1.000                                  | PC    |    |
|           |  |   | Code       | Description  | Qty   | UOM  |             |   |       |          |  |  |       |          |  |  |       |    |
|           |  |   | GN1240A0   | COLUMN-GLA<br>SS BLACK<br>SILICON SEAL               | 4.000   | PC   |             |   |       |          |  |  |       |          |  |  |       |    |
|           |  |   | VT1190A0   |  | 1.000   | PC   |             |   |       |          |  |  |       |          |  |  |       |    |
|           |  |   | KVT1155A   | LINEMICRO XF023<br>INTERNAL GLASS KI                 | <table border="1"> <thead> <tr> <th>Code</th> <th>Description</th> <th>Qty</th> <th>UOM</th> </tr> </thead> <tbody> <tr> <td>GN1240A0</td> <td>COLUMN-GLA<br/>SS BLACK<br/>SILICON SEAL</td> <td>4.000</td> <td>PC</td> </tr> <tr> <td>VT1155A0</td> <td>INTERNAL<br/>GLASS<br/>512X362X4<br/>LineMicro XF02</td> <td>1.000</td> <td>PC</td> </tr> </tbody> </table>      | Code | Description | Qty   | UOM   | GN1240A0 | COLUMN-GLA<br>SS BLACK<br>SILICON SEAL | 4.000  | PC    | VT1155A0 | INTERNAL<br>GLASS<br>512X362X4<br>LineMicro XF02     | 1.000                                  | PC    |    |
|           |  |   | Code       | Description  | Qty   | UOM  |             |   |       |          |  |  |       |          |  |  |       |    |
| GN1240A0  | COLUMN-GLA<br>SS BLACK<br>SILICON SEAL           | 4.000   | PC         |  |   |      |             |   |       |          |  |  |       |          |  |  |       |    |
| VT1155A0  | INTERNAL<br>GLASS<br>512X362X4<br>LineMicro XF02 | 1.000   | PC         |  |   |      |             |   |       |          |  |  |       |          |  |  |       |    |
| KVT1150A  | LINEMICRO XF013<br>INTERNAL GLASS KI             | <table border="1"> <thead> <tr> <th>Code</th> <th>Description</th> <th>Qty</th> <th>UOM</th> </tr> </thead> <tbody> <tr> <td>GN1240A0</td> <td>COLUMN-GLA<br/>SS BLACK<br/>SILICON SEAL</td> <td>4.000</td> <td>PC</td> </tr> <tr> <td>VT1150A0</td> <td>INTERNAL<br/>GLASS<br/>512x292x4<br/>LineMicro XF00</td> <td>1.000</td> <td>PC</td> </tr> </tbody> </table>  | Code       | Description  | Qty   | UOM  | GN1240A0    | COLUMN-GLA<br>SS BLACK<br>SILICON SEAL      | 4.000 | PC       | VT1150A0                               | INTERNAL<br>GLASS<br>512x292x4<br>LineMicro XF00 | 1.000 | PC       |  |  |       |    |
| Code      | Description                                      | Qty   | UOM        |  |   |      |             |   |       |          |  |  |       |          |  |  |       |    |
| GN1240A0  | COLUMN-GLA<br>SS BLACK<br>SILICON SEAL           | 4.000   | PC         |  |   |      |             |   |       |          |  |  |       |          |  |  |       |    |
| VT1150A0  | INTERNAL<br>GLASS<br>512x292x4<br>LineMicro XF00 | 1.000   | PC         |  |   |      |             |   |       |          |  |  |       |          |  |  |       |    |
| KVT1145A  | LINEMICRO XF003<br>INTERNAL GLASS KI             | <table border="1"> <thead> <tr> <th>Code</th> <th>Description</th> <th>Qty</th> <th>UOM</th> </tr> </thead> <tbody> <tr> <td>GN1240A0</td> <td>COLUMN-GLA<br/>SS BLACK<br/>SILICON SEAL</td> <td>4.000</td> <td>PC</td> </tr> <tr> <td>VT1145A0</td> <td>INNER GLASS<br/>392x292x4<br/>BETFL L.</td> <td>1.000</td> <td>PC</td> </tr> </tbody> </table>   | Code       | Description  | Qty   | UOM  | GN1240A0    | COLUMN-GLA<br>SS BLACK<br>SILICON SEAL      | 4.000 | PC       | VT1145A0                               | INNER GLASS<br>392x292x4<br>BETFL L.             | 1.000 | PC       |  |  |       |    |
| Code      | Description                                      | Qty   | UOM        |  |   |      |             |   |       |          |  |  |       |          |  |  |       |    |
| GN1240A0  | COLUMN-GLA<br>SS BLACK<br>SILICON SEAL           | 4.000   | PC         |  |   |      |             |   |       |          |  |  |       |          |  |  |       |    |
| VT1145A0  | INNER GLASS<br>392x292x4<br>BETFL L.             | 1.000   | PC         |  |   |      |             |   |       |          |  |  |       |          |  |  |       |    |
| KVM1376A  | XF023-XF043 RIGHT<br>DOOR COLUMN KIT             | <table border="1"> <thead> <tr> <th>Code</th> <th>Description</th> <th>Qty</th> <th>UOM</th> </tr> </thead> <tbody> <tr> <td>0H3110A1</td> <td>GLASS<br/>HOLDING<br/>ST.STEEL<br/>UPPER PLATE</td> <td>1.000</td> <td>PC</td> </tr> <tr> <td>0H3111A2</td> <td>GLASS<br/>HOLDING<br/>ST.STEEL<br/>LOWER PLATE</td> <td>1.000</td> <td>PC</td> </tr> <tr> <td>GN1240A0</td> <td>COLUMN-GLA<br/>SS BLACK<br/>SILICON SEAL</td> <td>2.000</td> <td>PC</td> </tr> </tbody> </table> | Code       | Description  | Qty   | UOM  | 0H3110A1    | GLASS<br>HOLDING<br>ST.STEEL<br>UPPER PLATE | 1.000 | PC       | 0H3111A2                               | GLASS<br>HOLDING<br>ST.STEEL<br>LOWER PLATE      | 1.000 | PC       | GN1240A0   | COLUMN-GLA<br>SS BLACK<br>SILICON SEAL | 2.000 | PC |
| Code      | Description                                      | Qty   | UOM        |  |   |      |             |   |       |          |  |  |       |          |  |  |       |    |
| 0H3110A1  | GLASS<br>HOLDING<br>ST.STEEL<br>UPPER PLATE      | 1.000   | PC         |  |   |      |             |   |       |          |  |  |       |          |  |  |       |    |
| 0H3111A2  | GLASS<br>HOLDING<br>ST.STEEL<br>LOWER PLATE      | 1.000   | PC         |  |   |      |             |   |       |          |  |  |       |          |  |  |       |    |
| GN1240A0  | COLUMN-GLA<br>SS BLACK<br>SILICON SEAL           | 2.000   | PC         |  |   |      |             |   |       |          |  |  |       |          |  |  |       |    |





| COMPONENT |  |  | SPARE PART |  |   |      |             |   |       |          |   |   |       |          |  |  |       |          |  |                                       |       |          |                                       |       |    |          |  |       |    |          |                                 |       |    |          |                                     |       |    |
|-----------|--|--|------------|--|---|------|-------------|---|-------|----------|---|---|-------|----------|--|--|-------|----------|--|---------------------------------------|-------|----------|---------------------------------------|-------|----|----------|--|-------|----|----------|---------------------------------|-------|----|----------|-------------------------------------|-------|----|
| Code      | Description                                      | Image  | Code       | Description                                      | Kit components  |      |             |   |       |          |   |   |       |          |  |  |       |          |  |                                       |       |          |                                       |       |    |          |  |       |    |          |                                 |       |    |          |                                     |       |    |
| GN1240A   | COLUMN-GLASS<br>BLACK SILICON SEA                |   | KVM1376A   | XF023-XF043 RIGHT<br>DOOR COLUMN KIT             | <table border="1"> <thead> <tr> <th>Code</th> <th>Description</th> <th>Qty</th> <th>UOM</th> </tr> </thead> <tbody> <tr> <td>VI1865A0</td> <td>5X10 TCB+<br/>SELF-THREADI<br/>NG SCREW</td> <td>1.000</td> <td>PC</td> </tr> <tr> <td>VI1870A0</td> <td>50x50<br/>SELF-THREADI<br/>NG SCREW<br/>FOR PLASTIC</td> <td>1.000</td> <td>PC</td> </tr> <tr> <td>VM1376A1</td> <td>H381 LMC<br/>RIGHT DOOR<br/>COLUMN</td> <td>1.000</td> <td>PC</td> </tr> <tr> <td>VM1380B0</td> <td>L.MICRO<br/>GLASS-DOOR<br/>FIXING CAP</td> <td>1.000</td> <td>PC</td> </tr> </tbody> </table>  | Code | Description | Qty   | UOM   | VI1865A0 | 5X10 TCB+<br>SELF-THREADI<br>NG SCREW       | 1.000                                       | PC    | VI1870A0 | 50x50<br>SELF-THREADI<br>NG SCREW<br>FOR PLASTIC | 1.000                                  | PC    | VM1376A1 | H381 LMC<br>RIGHT DOOR<br>COLUMN       | 1.000                                 | PC    | VM1380B0 | L.MICRO<br>GLASS-DOOR<br>FIXING CAP   | 1.000 | PC |          |  |       |    |          |                                 |       |    |          |                                     |       |    |
|           |  |  | Code       | Description                                      | Qty   | UOM  |             |   |       |          |   |   |       |          |  |  |       |          |  |                                       |       |          |                                       |       |    |          |  |       |    |          |                                 |       |    |          |                                     |       |    |
|           |  |  | VI1865A0   | 5X10 TCB+<br>SELF-THREADI<br>NG SCREW            | 1.000   | PC   |             |   |       |          |   |   |       |          |  |  |       |          |  |                                       |       |          |                                       |       |    |          |  |       |    |          |                                 |       |    |          |                                     |       |    |
|           |  |  | VI1870A0   | 50x50<br>SELF-THREADI<br>NG SCREW<br>FOR PLASTIC | 1.000   | PC   |             |   |       |          |   |   |       |          |  |  |       |          |  |                                       |       |          |                                       |       |    |          |  |       |    |          |                                 |       |    |          |                                     |       |    |
|           |  |  | VM1376A1   | H381 LMC<br>RIGHT DOOR<br>COLUMN                 | 1.000   | PC   |             |   |       |          |   |   |       |          |  |  |       |          |  |                                       |       |          |                                       |       |    |          |  |       |    |          |                                 |       |    |          |                                     |       |    |
|           |  |  | VM1380B0   | L.MICRO<br>GLASS-DOOR<br>FIXING CAP              | 1.000   | PC   |             |   |       |          |   |   |       |          |  |  |       |          |  |                                       |       |          |                                       |       |    |          |  |       |    |          |                                 |       |    |          |                                     |       |    |
|           |  |  | KVM1375A   | XF023-XF043 LEFT<br>DOOR COLUMN KIT              | <table border="1"> <thead> <tr> <th>Code</th> <th>Description</th> <th>Qty</th> <th>UOM</th> </tr> </thead> <tbody> <tr> <td>0H3110A1</td> <td>GLASS<br/>HOLDING<br/>ST.STEEL<br/>UPPER PLATE</td> <td>1.000</td> <td>PC</td> </tr> <tr> <td>0H3111A2</td> <td>GLASS<br/>HOLDING<br/>ST.STEEL<br/>LOWER PLATE</td> <td>1.000</td> <td>PC</td> </tr> <tr> <td>GN1240A0</td> <td>COLUMN-GLA<br/>SS BLACK<br/>SILICON SEAL</td> <td>2.000</td> <td>PC</td> </tr> <tr> <td>VI1865A0</td> <td>5X10 TCB+<br/>SELF-THREADI<br/>NG SCREW</td> <td>1.000</td> <td>PC</td> </tr> <tr> <td>VI1870A0</td> <td>50x50<br/>SELF-THREADI<br/>NG SCREW<br/>FOR PLASTIC</td> <td>1.000</td> <td>PC</td> </tr> <tr> <td>VM1375A1</td> <td>H381 LMC<br/>LEFT DOOR<br/>COLUMN</td> <td>1.000</td> <td>PC</td> </tr> <tr> <td>VM1380B0</td> <td>L.MICRO<br/>GLASS-DOOR<br/>FIXING CAP</td> <td>1.000</td> <td>PC</td> </tr> </tbody> </table> | Code | Description | Qty   | UOM   | 0H3110A1 | GLASS<br>HOLDING<br>ST.STEEL<br>UPPER PLATE | 1.000                                       | PC    | 0H3111A2 | GLASS<br>HOLDING<br>ST.STEEL<br>LOWER PLATE      | 1.000                                  | PC    | GN1240A0 | COLUMN-GLA<br>SS BLACK<br>SILICON SEAL | 2.000                                 | PC    | VI1865A0 | 5X10 TCB+<br>SELF-THREADI<br>NG SCREW | 1.000 | PC | VI1870A0 | 50x50<br>SELF-THREADI<br>NG SCREW<br>FOR PLASTIC | 1.000 | PC | VM1375A1 | H381 LMC<br>LEFT DOOR<br>COLUMN | 1.000 | PC | VM1380B0 | L.MICRO<br>GLASS-DOOR<br>FIXING CAP | 1.000 | PC |
|           |  |  | Code       | Description                                      | Qty   | UOM  |             |   |       |          |   |   |       |          |  |  |       |          |  |                                       |       |          |                                       |       |    |          |  |       |    |          |                                 |       |    |          |                                     |       |    |
|           |  |  | 0H3110A1   | GLASS<br>HOLDING<br>ST.STEEL<br>UPPER PLATE      | 1.000   | PC   |             |   |       |          |   |   |       |          |  |  |       |          |  |                                       |       |          |                                       |       |    |          |  |       |    |          |                                 |       |    |          |                                     |       |    |
|           |  |  | 0H3111A2   | GLASS<br>HOLDING<br>ST.STEEL<br>LOWER PLATE      | 1.000   | PC   |             |   |       |          |   |   |       |          |  |  |       |          |  |                                       |       |          |                                       |       |    |          |  |       |    |          |                                 |       |    |          |                                     |       |    |
|           |  |  | GN1240A0   | COLUMN-GLA<br>SS BLACK<br>SILICON SEAL           | 2.000   | PC   |             |   |       |          |   |   |       |          |  |  |       |          |  |                                       |       |          |                                       |       |    |          |  |       |    |          |                                 |       |    |          |                                     |       |    |
|           |  |  | VI1865A0   | 5X10 TCB+<br>SELF-THREADI<br>NG SCREW            | 1.000   | PC   |             |   |       |          |   |   |       |          |  |  |       |          |  |                                       |       |          |                                       |       |    |          |  |       |    |          |                                 |       |    |          |                                     |       |    |
| VI1870A0  | 50x50<br>SELF-THREADI<br>NG SCREW<br>FOR PLASTIC | 1.000  | PC         |  |   |      |             |   |       |          |   |   |       |          |  |  |       |          |  |                                       |       |          |                                       |       |    |          |  |       |    |          |                                 |       |    |          |                                     |       |    |
| VM1375A1  | H381 LMC<br>LEFT DOOR<br>COLUMN                  | 1.000  | PC         |  |   |      |             |   |       |          |   |   |       |          |  |  |       |          |  |                                       |       |          |                                       |       |    |          |  |       |    |          |                                 |       |    |          |                                     |       |    |
| VM1380B0  | L.MICRO<br>GLASS-DOOR<br>FIXING CAP              | 1.000  | PC         |  |   |      |             |   |       |          |   |   |       |          |  |  |       |          |  |                                       |       |          |                                       |       |    |          |  |       |    |          |                                 |       |    |          |                                     |       |    |
| KVM1371A  | XF003-XF013 RIGHT<br>DOOR COLUMN KIT             | <table border="1"> <thead> <tr> <th>Code</th> <th>Description</th> <th>Qty</th> <th>UOM</th> </tr> </thead> <tbody> <tr> <td>0H3110A1</td> <td>GLASS<br/>HOLDING<br/>ST.STEEL<br/>UPPER PLATE</td> <td>1.000</td> <td>PC</td> </tr> <tr> <td>0H3111A2</td> <td>GLASS<br/>HOLDING<br/>ST.STEEL<br/>LOWER PLATE</td> <td>1.000</td> <td>PC</td> </tr> <tr> <td>GN1240A0</td> <td>COLUMN-GLA<br/>SS BLACK<br/>SILICON SEAL</td> <td>2.000</td> <td>PC</td> </tr> <tr> <td>VI1865A0</td> <td>5X10 TCB+<br/>SELF-THREADI<br/>NG SCREW</td> <td>1.000</td> <td>PC</td> </tr> </tbody> </table> | Code       | Description                                      | Qty   | UOM  | 0H3110A1    | GLASS<br>HOLDING<br>ST.STEEL<br>UPPER PLATE | 1.000 | PC       | 0H3111A2                                    | GLASS<br>HOLDING<br>ST.STEEL<br>LOWER PLATE | 1.000 | PC       | GN1240A0   | COLUMN-GLA<br>SS BLACK<br>SILICON SEAL | 2.000 | PC       | VI1865A0                               | 5X10 TCB+<br>SELF-THREADI<br>NG SCREW | 1.000 | PC       |                                       |       |    |          |  |       |    |          |                                 |       |    |          |                                     |       |    |
| Code      | Description                                      | Qty  | UOM        |  |   |      |             |   |       |          |   |   |       |          |  |  |       |          |  |                                       |       |          |                                       |       |    |          |  |       |    |          |                                 |       |    |          |                                     |       |    |
| 0H3110A1  | GLASS<br>HOLDING<br>ST.STEEL<br>UPPER PLATE      | 1.000  | PC         |  |   |      |             |   |       |          |   |   |       |          |  |  |       |          |  |                                       |       |          |                                       |       |    |          |  |       |    |          |                                 |       |    |          |                                     |       |    |
| 0H3111A2  | GLASS<br>HOLDING<br>ST.STEEL<br>LOWER PLATE      | 1.000  | PC         |  |   |      |             |   |       |          |   |   |       |          |  |  |       |          |  |                                       |       |          |                                       |       |    |          |  |       |    |          |                                 |       |    |          |                                     |       |    |
| GN1240A0  | COLUMN-GLA<br>SS BLACK<br>SILICON SEAL           | 2.000  | PC         |  |   |      |             |   |       |          |   |   |       |          |  |  |       |          |  |                                       |       |          |                                       |       |    |          |  |       |    |          |                                 |       |    |          |                                     |       |    |
| VI1865A0  | 5X10 TCB+<br>SELF-THREADI<br>NG SCREW            | 1.000  | PC         |  |   |      |             |   |       |          |   |   |       |          |  |  |       |          |  |                                       |       |          |                                       |       |    |          |  |       |    |          |                                 |       |    |          |                                     |       |    |



| COMPONENT  |  |   | SPARE PART  |                                      |  |  |             |  |   |          |  |       |    |
|--|--|---|---|--------------------------------------|--|--|-------------|--|---|----------|--|-------|----|
| Code   | Description                                      | Image   | Code  | Description                          | Kit components   |  |             |  |   |          |  |       |    |
| GN1240A  | COLUMN-GLASS<br>BLACK SILICON SEA                |    | KVM1371A  | XF003-XF013 RIGHT<br>DOOR COLUMN KIT | <table border="1"> <thead> <tr> <th>Code</th> <th>Description</th> <th>Qty</th> <th>UOM</th> </tr> </thead> <tbody> <tr> <td>VI1870A0</td> <td>50x50<br/>SELF-THREADI<br/>NG SCREW<br/>FOR PLASTIC</td> <td>1.000</td> <td>PC</td> </tr> </tbody> </table> | Code   | Description | Qty                                    | UOM   | VI1870A0 | 50x50<br>SELF-THREADI<br>NG SCREW<br>FOR PLASTIC | 1.000 | PC |
|  |  |   |   |                                      | Code   | Description                                      | Qty         | UOM                                    |   |          |  |       |    |
|  |  |   |   |                                      | VI1870A0   | 50x50<br>SELF-THREADI<br>NG SCREW<br>FOR PLASTIC | 1.000       | PC                                     |   |          |  |       |    |
|  |  |   |   |                                      | <table border="1"> <thead> <tr> <th>Code</th> <th>Description</th> <th>Qty</th> <th>UOM</th> </tr> </thead> <tbody> <tr> <td>VM1371A1</td> <td>H311 LMC<br/>RIGHT DOOR<br/>COLUMN</td> <td>1.000</td> <td>PC</td> </tr> </tbody> </table>                  | Code   | Description | Qty                                    | UOM   | VM1371A1 | H311 LMC<br>RIGHT DOOR<br>COLUMN                 | 1.000 | PC |
|  |  |   |   |                                      | Code   | Description                                      | Qty         | UOM                                    |   |          |  |       |    |
|  |  |   | VM1371A1  | H311 LMC<br>RIGHT DOOR<br>COLUMN     | 1.000  | PC   |             |  |   |          |  |       |    |
|  |  |   | <table border="1"> <thead> <tr> <th>Code</th> <th>Description</th> <th>Qty</th> <th>UOM</th> </tr> </thead> <tbody> <tr> <td>VM1380B0</td> <td>L.MICRO<br/>GLASS-DOOR<br/>FIXING CAP</td> <td>1.000</td> <td>PC</td> </tr> </tbody> </table>          | Code                                 | Description  | Qty  | UOM         | VM1380B0                               | L.MICRO<br>GLASS-DOOR<br>FIXING CAP         | 1.000    | PC   |       |    |
|  |  |   | Code  | Description                          | Qty  | UOM  |             |  |   |          |  |       |    |
|  |  |   | VM1380B0  | L.MICRO<br>GLASS-DOOR<br>FIXING CAP  | 1.000  | PC   |             |  |   |          |  |       |    |
|  |  |   | <table border="1"> <thead> <tr> <th>Code</th> <th>Description</th> <th>Qty</th> <th>UOM</th> </tr> </thead> <tbody> <tr> <td>0H3110A1</td> <td>GLASS<br/>HOLDING<br/>ST.STEEL<br/>UPPER PLATE</td> <td>1.000</td> <td>PC</td> </tr> </tbody> </table> | Code                                 | Description  | Qty  | UOM         | 0H3110A1                               | GLASS<br>HOLDING<br>ST.STEEL<br>UPPER PLATE | 1.000    | PC   |       |    |
| Code   | Description                                      | Qty   | UOM   |                                      |  |  |             |  |   |          |  |       |    |
| 0H3110A1   | GLASS<br>HOLDING<br>ST.STEEL<br>UPPER PLATE      | 1.000   | PC  |                                      |  |  |             |  |   |          |  |       |    |
| <table border="1"> <thead> <tr> <th>Code</th> <th>Description</th> <th>Qty</th> <th>UOM</th> </tr> </thead> <tbody> <tr> <td>0H3111A2</td> <td>GLASS<br/>HOLDING<br/>ST.STEEL<br/>LOWER PLATE</td> <td>1.000</td> <td>PC</td> </tr> </tbody> </table>      | Code   | Description   | Qty   | UOM                                  | 0H3111A2   | GLASS<br>HOLDING<br>ST.STEEL<br>LOWER PLATE      | 1.000       | PC                                     |   |          |  |       |    |
| Code   | Description                                      | Qty   | UOM   |                                      |  |  |             |  |   |          |  |       |    |
| 0H3111A2   | GLASS<br>HOLDING<br>ST.STEEL<br>LOWER PLATE      | 1.000   | PC  |                                      |  |  |             |  |   |          |  |       |    |
| <table border="1"> <thead> <tr> <th>Code</th> <th>Description</th> <th>Qty</th> <th>UOM</th> </tr> </thead> <tbody> <tr> <td>GN1240A0</td> <td>COLUMN-GLA<br/>SS BLACK<br/>SILICON SEAL</td> <td>2.000</td> <td>PC</td> </tr> </tbody> </table>            | Code   | Description   | Qty   | UOM                                  | GN1240A0   | COLUMN-GLA<br>SS BLACK<br>SILICON SEAL           | 2.000       | PC                                     |   |          |  |       |    |
| Code   | Description                                      | Qty   | UOM   |                                      |  |  |             |  |   |          |  |       |    |
| GN1240A0   | COLUMN-GLA<br>SS BLACK<br>SILICON SEAL           | 2.000   | PC  |                                      |  |  |             |  |   |          |  |       |    |
| <table border="1"> <thead> <tr> <th>Code</th> <th>Description</th> <th>Qty</th> <th>UOM</th> </tr> </thead> <tbody> <tr> <td>VI1865A0</td> <td>5X10 TCB+<br/>SELF-THREADI<br/>NG SCREW</td> <td>1.000</td> <td>PC</td> </tr> </tbody> </table>             | Code   | Description   | Qty   | UOM                                  | VI1865A0   | 5X10 TCB+<br>SELF-THREADI<br>NG SCREW            | 1.000       | PC                                     |   |          |  |       |    |
| Code   | Description                                      | Qty   | UOM   |                                      |  |  |             |  |   |          |  |       |    |
| VI1865A0   | 5X10 TCB+<br>SELF-THREADI<br>NG SCREW            | 1.000   | PC  |                                      |  |  |             |  |   |          |  |       |    |
| <table border="1"> <thead> <tr> <th>Code</th> <th>Description</th> <th>Qty</th> <th>UOM</th> </tr> </thead> <tbody> <tr> <td>VI1870A0</td> <td>50x50<br/>SELF-THREADI<br/>NG SCREW<br/>FOR PLASTIC</td> <td>1.000</td> <td>PC</td> </tr> </tbody> </table> | Code   | Description   | Qty   | UOM                                  | VI1870A0   | 50x50<br>SELF-THREADI<br>NG SCREW<br>FOR PLASTIC | 1.000       | PC                                     |   |          |  |       |    |
| Code   | Description                                      | Qty   | UOM   |                                      |  |  |             |  |   |          |  |       |    |
| VI1870A0   | 50x50<br>SELF-THREADI<br>NG SCREW<br>FOR PLASTIC | 1.000   | PC  |                                      |  |  |             |  |   |          |  |       |    |
| <table border="1"> <thead> <tr> <th>Code</th> <th>Description</th> <th>Qty</th> <th>UOM</th> </tr> </thead> <tbody> <tr> <td>VM1370A1</td> <td>H311 LMC<br/>LEFT DOOR<br/>COLUMN</td> <td>1.000</td> <td>PC</td> </tr> </tbody> </table>                   | Code   | Description   | Qty   | UOM                                  | VM1370A1   | H311 LMC<br>LEFT DOOR<br>COLUMN                  | 1.000       | PC                                     |   |          |  |       |    |
| Code   | Description                                      | Qty   | UOM   |                                      |  |  |             |  |   |          |  |       |    |
| VM1370A1   | H311 LMC<br>LEFT DOOR<br>COLUMN                  | 1.000   | PC  |                                      |  |  |             |  |   |          |  |       |    |
| <table border="1"> <thead> <tr> <th>Code</th> <th>Description</th> <th>Qty</th> <th>UOM</th> </tr> </thead> <tbody> <tr> <td>VM1380B0</td> <td>L.MICRO<br/>GLASS-DOOR<br/>FIXING CAP</td> <td>1.000</td> <td>PC</td> </tr> </tbody> </table>               | Code   | Description   | Qty   | UOM                                  | VM1380B0   | L.MICRO<br>GLASS-DOOR<br>FIXING CAP              | 1.000       | PC                                     |   |          |  |       |    |
| Code   | Description                                      | Qty   | UOM   |                                      |  |  |             |  |   |          |  |       |    |
| VM1380B0   | L.MICRO<br>GLASS-DOOR<br>FIXING CAP              | 1.000   | PC  |                                      |  |  |             |  |   |          |  |       |    |
| KVM1370A   | XF003-XF013 LEFT<br>DOOR COLUMN KIT              | <table border="1"> <thead> <tr> <th>Code</th> <th>Description</th> <th>Qty</th> <th>UOM</th> </tr> </thead> <tbody> <tr> <td>GN1240A0</td> <td>COLUMN-GLA<br/>SS BLACK<br/>SILICON SEAL</td> <td>4.000</td> <td>PC</td> </tr> </tbody> </table> | Code  | Description                          | Qty  | UOM  | GN1240A0    | COLUMN-GLA<br>SS BLACK<br>SILICON SEAL | 4.000                                       | PC       |  |       |    |
|  |  | Code  | Description   | Qty                                  | UOM  |  |             |  |   |          |  |       |    |
| GN1240A0   | COLUMN-GLA<br>SS BLACK<br>SILICON SEAL           | 4.000   | PC  |                                      |  |  |             |  |   |          |  |       |    |
| <table border="1"> <thead> <tr> <th>Code</th> <th>Description</th> <th>Qty</th> <th>UOM</th> </tr> </thead> <tbody> <tr> <td>GN1240A0</td> <td>COLUMN-GLA<br/>SS BLACK<br/>SILICON SEAL</td> <td>4.000</td> <td>PC</td> </tr> </tbody> </table>            | Code   | Description   | Qty   | UOM                                  | GN1240A0   | COLUMN-GLA<br>SS BLACK<br>SILICON SEAL           | 4.000       | PC                                     |   |          |  |       |    |
| Code   | Description                                      | Qty   | UOM   |                                      |  |  |             |  |   |          |  |       |    |
| GN1240A0   | COLUMN-GLA<br>SS BLACK<br>SILICON SEAL           | 4.000   | PC  |                                      |  |  |             |  |   |          |  |       |    |
| KGN1240A   | COLUMN-GLASS<br>GASKET 4 PCS KIT                 | <table border="1"> <thead> <tr> <th>Code</th> <th>Description</th> <th>Qty</th> <th>UOM</th> </tr> </thead> <tbody> <tr> <td>GN1240A0</td> <td>COLUMN-GLA<br/>SS BLACK<br/>SILICON SEAL</td> <td>4.000</td> <td>PC</td> </tr> </tbody> </table> | Code  | Description                          | Qty  | UOM  | GN1240A0    | COLUMN-GLA<br>SS BLACK<br>SILICON SEAL | 4.000                                       | PC       |  |       |    |
|  |  | Code  | Description   | Qty                                  | UOM  |  |             |  |   |          |  |       |    |
|  |  | GN1240A0  | COLUMN-GLA<br>SS BLACK<br>SILICON SEAL  | 4.000                                | PC   |  |             |  |   |          |  |       |    |
| <table border="1"> <thead> <tr> <th>Code</th> <th>Description</th> <th>Qty</th> <th>UOM</th> </tr> </thead> <tbody> <tr> <td>GN1240A0</td> <td>COLUMN-GLA<br/>SS BLACK<br/>SILICON SEAL</td> <td>4.000</td> <td>PC</td> </tr> </tbody> </table>            | Code   | Description   | Qty   | UOM                                  | GN1240A0   | COLUMN-GLA<br>SS BLACK<br>SILICON SEAL           | 4.000       | PC                                     |   |          |  |       |    |
| Code   | Description                                      | Qty   | UOM   |                                      |  |  |             |  |   |          |  |       |    |
| GN1240A0   | COLUMN-GLA<br>SS BLACK<br>SILICON SEAL           | 4.000   | PC  |                                      |  |  |             |  |   |          |  |       |    |
| <table border="1"> <thead> <tr> <th>Code</th> <th>Description</th> <th>Qty</th> <th>UOM</th> </tr> </thead> <tbody> <tr> <td>GN1240A0</td> <td>COLUMN-GLA<br/>SS BLACK<br/>SILICON SEAL</td> <td>4.000</td> <td>PC</td> </tr> </tbody> </table>            | Code   | Description   | Qty   | UOM                                  | GN1240A0   | COLUMN-GLA<br>SS BLACK<br>SILICON SEAL           | 4.000       | PC                                     |   |          |  |       |    |
| Code   | Description                                      | Qty   | UOM   |                                      |  |  |             |  |   |          |  |       |    |
| GN1240A0   | COLUMN-GLA<br>SS BLACK<br>SILICON SEAL           | 4.000   | PC  |                                      |  |  |             |  |   |          |  |       |    |
| VM1370A  | H311 LMC LEFT<br>DOOR COLUMN                     |    | KVM1370A  | XF003-XF013 LEFT<br>DOOR COLUMN KIT  | <table border="1"> <thead> <tr> <th>Code</th> <th>Description</th> <th>Qty</th> <th>UOM</th> </tr> </thead> <tbody> <tr> <td>0H3110A1</td> <td>GLASS<br/>HOLDING<br/>ST.STEEL<br/>UPPER PLATE</td> <td>1.000</td> <td>PC</td> </tr> </tbody> </table>      | Code   | Description | Qty                                    | UOM   | 0H3110A1 | GLASS<br>HOLDING<br>ST.STEEL<br>UPPER PLATE      | 1.000 | PC |
|  |  |   |   |                                      | Code   | Description                                      | Qty         | UOM                                    |   |          |  |       |    |
|  |  |   |   |                                      | 0H3110A1   | GLASS<br>HOLDING<br>ST.STEEL<br>UPPER PLATE      | 1.000       | PC                                     |   |          |  |       |    |
| <table border="1"> <thead> <tr> <th>Code</th> <th>Description</th> <th>Qty</th> <th>UOM</th> </tr> </thead> <tbody> <tr> <td>0H3111A2</td> <td>GLASS<br/>HOLDING<br/>ST.STEEL<br/>LOWER PLATE</td> <td>1.000</td> <td>PC</td> </tr> </tbody> </table>      | Code   | Description   | Qty   | UOM                                  | 0H3111A2   | GLASS<br>HOLDING<br>ST.STEEL<br>LOWER PLATE      | 1.000       | PC                                     |   |          |  |       |    |
| Code   | Description                                      | Qty   | UOM   |                                      |  |  |             |  |   |          |  |       |    |
| 0H3111A2   | GLASS<br>HOLDING<br>ST.STEEL<br>LOWER PLATE      | 1.000   | PC  |                                      |  |  |             |  |   |          |  |       |    |
| <table border="1"> <thead> <tr> <th>Code</th> <th>Description</th> <th>Qty</th> <th>UOM</th> </tr> </thead> <tbody> <tr> <td>GN1240A0</td> <td>COLUMN-GLA<br/>SS BLACK<br/>SILICON SEAL</td> <td>2.000</td> <td>PC</td> </tr> </tbody> </table>            | Code   | Description   | Qty   | UOM                                  | GN1240A0   | COLUMN-GLA<br>SS BLACK<br>SILICON SEAL           | 2.000       | PC                                     |   |          |  |       |    |
| Code   | Description                                      | Qty   | UOM   |                                      |  |  |             |  |   |          |  |       |    |
| GN1240A0   | COLUMN-GLA<br>SS BLACK<br>SILICON SEAL           | 2.000   | PC  |                                      |  |  |             |  |   |          |  |       |    |



| COMPONENT |  |   | SPARE PART |                                   |   |  |             |     |     |          |                                     |       |    |          |  |       |    |          |                                 |       |    |          |                                |       |    |          |  |       |    |          |                            |       |    |          |                               |       |    |
|-----------|--|---|------------|-----------------------------------|---|--|-------------|-----|-----|----------|-------------------------------------|-------|----|----------|--|-------|----|----------|---------------------------------|-------|----|----------|--------------------------------|-------|----|----------|--|-------|----|----------|----------------------------|-------|----|----------|-------------------------------|-------|----|
| Code      | Description                            | Image   | Code       | Description                       | Kit components  |  |             |     |     |          |                                     |       |    |          |  |       |    |          |                                 |       |    |          |                                |       |    |          |  |       |    |          |                            |       |    |          |                               |       |    |
| VM1370A   | H311 LMC LEFT DOOR COLUMN              |    | KVM1370A   | XF003-XF013 LEFT DOOR COLUMN KIT  | <table border="1"> <thead> <tr> <th>Code</th> <th>Description</th> <th>Qty</th> <th>UOM</th> </tr> </thead> <tbody> <tr> <td>VI1865A0</td> <td>5X10 TCB+ SELF-THREADING SCREW</td> <td>1.000</td> <td>PC</td> </tr> <tr> <td>VI1870A0</td> <td>50x50 SELF-THREADING SCREW FOR PLASTIC</td> <td>1.000</td> <td>PC</td> </tr> <tr> <td>VM1370A1</td> <td>H311 LMC LEFT DOOR COLUMN</td> <td>1.000</td> <td>PC</td> </tr> <tr> <td>VM1380B0</td> <td>L.MICRO GLASS-DOOR FIXING CAP</td> <td>1.000</td> <td>PC</td> </tr> </tbody> </table>   | Code                                   | Description | Qty | UOM | VI1865A0 | 5X10 TCB+ SELF-THREADING SCREW      | 1.000 | PC | VI1870A0 | 50x50 SELF-THREADING SCREW FOR PLASTIC | 1.000 | PC | VM1370A1 | H311 LMC LEFT DOOR COLUMN       | 1.000 | PC | VM1380B0 | L.MICRO GLASS-DOOR FIXING CAP  | 1.000 | PC |          |  |       |    |          |                            |       |    |          |                               |       |    |
|           |  |   |            |                                   | Code  | Description                            | Qty         | UOM |     |          |                                     |       |    |          |  |       |    |          |                                 |       |    |          |                                |       |    |          |  |       |    |          |                            |       |    |          |                               |       |    |
|           |  |   |            |                                   | VI1865A0  | 5X10 TCB+ SELF-THREADING SCREW         | 1.000       | PC  |     |          |                                     |       |    |          |  |       |    |          |                                 |       |    |          |                                |       |    |          |  |       |    |          |                            |       |    |          |                               |       |    |
|           |  |   |            |                                   | VI1870A0  | 50x50 SELF-THREADING SCREW FOR PLASTIC | 1.000       | PC  |     |          |                                     |       |    |          |  |       |    |          |                                 |       |    |          |                                |       |    |          |  |       |    |          |                            |       |    |          |                               |       |    |
| VM1370A1  | H311 LMC LEFT DOOR COLUMN              | 1.000   | PC         |                                   |   |  |             |     |     |          |                                     |       |    |          |  |       |    |          |                                 |       |    |          |                                |       |    |          |  |       |    |          |                            |       |    |          |                               |       |    |
| VM1380B0  | L.MICRO GLASS-DOOR FIXING CAP          | 1.000   | PC         |                                   |   |  |             |     |     |          |                                     |       |    |          |  |       |    |          |                                 |       |    |          |                                |       |    |          |  |       |    |          |                            |       |    |          |                               |       |    |
| VM1371A   | H311 LMC RIGHT DOOR COLUMN             |   | KVM1371A   | XF003-XF013 RIGHT DOOR COLUMN KIT | <table border="1"> <thead> <tr> <th>Code</th> <th>Description</th> <th>Qty</th> <th>UOM</th> </tr> </thead> <tbody> <tr> <td>0H3110A1</td> <td>GLASS HOLDING ST. STEEL UPPER PLATE</td> <td>1.000</td> <td>PC</td> </tr> <tr> <td>0H3111A2</td> <td>GLASS HOLDING ST. STEEL LOWER PLATE</td> <td>1.000</td> <td>PC</td> </tr> <tr> <td>GN1240A0</td> <td>COLUMN-GLASS BLACK SILICON SEAL</td> <td>2.000</td> <td>PC</td> </tr> <tr> <td>VI1865A0</td> <td>5X10 TCB+ SELF-THREADING SCREW</td> <td>1.000</td> <td>PC</td> </tr> <tr> <td>VI1870A0</td> <td>50x50 SELF-THREADING SCREW FOR PLASTIC</td> <td>1.000</td> <td>PC</td> </tr> <tr> <td>VM1371A1</td> <td>H311 LMC RIGHT DOOR COLUMN</td> <td>1.000</td> <td>PC</td> </tr> <tr> <td>VM1380B0</td> <td>L.MICRO GLASS-DOOR FIXING CAP</td> <td>1.000</td> <td>PC</td> </tr> </tbody> </table> | Code                                   | Description | Qty | UOM | 0H3110A1 | GLASS HOLDING ST. STEEL UPPER PLATE | 1.000 | PC | 0H3111A2 | GLASS HOLDING ST. STEEL LOWER PLATE    | 1.000 | PC | GN1240A0 | COLUMN-GLASS BLACK SILICON SEAL | 2.000 | PC | VI1865A0 | 5X10 TCB+ SELF-THREADING SCREW | 1.000 | PC | VI1870A0 | 50x50 SELF-THREADING SCREW FOR PLASTIC | 1.000 | PC | VM1371A1 | H311 LMC RIGHT DOOR COLUMN | 1.000 | PC | VM1380B0 | L.MICRO GLASS-DOOR FIXING CAP | 1.000 | PC |
|           |  |   |            |                                   | Code  | Description                            | Qty         | UOM |     |          |                                     |       |    |          |  |       |    |          |                                 |       |    |          |                                |       |    |          |  |       |    |          |                            |       |    |          |                               |       |    |
|           |  |   |            |                                   | 0H3110A1  | GLASS HOLDING ST. STEEL UPPER PLATE    | 1.000       | PC  |     |          |                                     |       |    |          |  |       |    |          |                                 |       |    |          |                                |       |    |          |  |       |    |          |                            |       |    |          |                               |       |    |
|           |  |   |            |                                   | 0H3111A2  | GLASS HOLDING ST. STEEL LOWER PLATE    | 1.000       | PC  |     |          |                                     |       |    |          |  |       |    |          |                                 |       |    |          |                                |       |    |          |  |       |    |          |                            |       |    |          |                               |       |    |
| GN1240A0  | COLUMN-GLASS BLACK SILICON SEAL        | 2.000   | PC         |                                   |   |  |             |     |     |          |                                     |       |    |          |  |       |    |          |                                 |       |    |          |                                |       |    |          |  |       |    |          |                            |       |    |          |                               |       |    |
| VI1865A0  | 5X10 TCB+ SELF-THREADING SCREW         | 1.000   | PC         |                                   |   |  |             |     |     |          |                                     |       |    |          |  |       |    |          |                                 |       |    |          |                                |       |    |          |  |       |    |          |                            |       |    |          |                               |       |    |
| VI1870A0  | 50x50 SELF-THREADING SCREW FOR PLASTIC | 1.000   | PC         |                                   |   |  |             |     |     |          |                                     |       |    |          |  |       |    |          |                                 |       |    |          |                                |       |    |          |  |       |    |          |                            |       |    |          |                               |       |    |
| VM1371A1  | H311 LMC RIGHT DOOR COLUMN             | 1.000   | PC         |                                   |   |  |             |     |     |          |                                     |       |    |          |  |       |    |          |                                 |       |    |          |                                |       |    |          |  |       |    |          |                            |       |    |          |                               |       |    |
| VM1380B0  | L.MICRO GLASS-DOOR FIXING CAP          | 1.000   | PC         |                                   |   |  |             |     |     |          |                                     |       |    |          |  |       |    |          |                                 |       |    |          |                                |       |    |          |  |       |    |          |                            |       |    |          |                               |       |    |
| VM1380B   | L.MICRO GLASS-DOOR FIXING CAP          |  | KVM1380B   | LMICRO DOOR CAP 2 PCS KIT         | <table border="1"> <thead> <tr> <th>Code</th> <th>Description</th> <th>Qty</th> <th>UOM</th> </tr> </thead> <tbody> <tr> <td>VI1865A0</td> <td>5X10 TCB+ SELF-THREADING SCREW</td> <td>2.000</td> <td>PC</td> </tr> <tr> <td>VM1380B0</td> <td>L.MICRO GLASS-DOOR FIXING CAP</td> <td>2.000</td> <td>PC</td> </tr> </tbody> </table>  | Code                                   | Description | Qty | UOM | VI1865A0 | 5X10 TCB+ SELF-THREADING SCREW      | 2.000 | PC | VM1380B0 | L.MICRO GLASS-DOOR FIXING CAP          | 2.000 | PC |          |                                 |       |    |          |                                |       |    |          |  |       |    |          |                            |       |    |          |                               |       |    |
|           |  |   |            |                                   | Code  | Description                            | Qty         | UOM |     |          |                                     |       |    |          |  |       |    |          |                                 |       |    |          |                                |       |    |          |  |       |    |          |                            |       |    |          |                               |       |    |
| VI1865A0  | 5X10 TCB+ SELF-THREADING SCREW         | 2.000   | PC         |                                   |   |  |             |     |     |          |                                     |       |    |          |  |       |    |          |                                 |       |    |          |                                |       |    |          |  |       |    |          |                            |       |    |          |                               |       |    |
| VM1380B0  | L.MICRO GLASS-DOOR FIXING CAP          | 2.000   | PC         |                                   |   |  |             |     |     |          |                                     |       |    |          |  |       |    |          |                                 |       |    |          |                                |       |    |          |  |       |    |          |                            |       |    |          |                               |       |    |



| COMPONENT |  |  | SPARE PART |                                      |   |      |             |   |       |          |  |   |       |          |                                      |                               |       |    |          |                                    |       |    |          |  |       |    |          |  |       |    |          |                                       |       |    |          |  |       |    |          |                            |       |    |          |                                 |       |    |          |                                  |       |    |          |                                     |       |    |          |                                      |       |    |          |  |       |    |
|-----------|--|--|------------|--------------------------------------|---|------|-------------|---|-------|----------|--|---|-------|----------|--------------------------------------|-------------------------------|-------|----|----------|------------------------------------|-------|----|----------|--|-------|----|----------|--|-------|----|----------|---------------------------------------|-------|----|----------|--|-------|----|----------|----------------------------|-------|----|----------|---------------------------------|-------|----|----------|----------------------------------|-------|----|----------|-------------------------------------|-------|----|----------|--------------------------------------|-------|----|----------|--|-------|----|
| Code      | Description  | Image  | Code       | Description                          | Kit components  |      |             |   |       |          |  |   |       |          |                                      |                               |       |    |          |                                    |       |    |          |  |       |    |          |  |       |    |          |                                       |       |    |          |  |       |    |          |                            |       |    |          |                                 |       |    |          |                                  |       |    |          |                                     |       |    |          |                                      |       |    |          |  |       |    |
| VT1145A   | INNER GLASS<br>392x292x4 BETFL L.                    |  | KVT1145A   | LINEMICRO XF003<br>INTERNAL GLASS KI | <table border="1"> <thead> <tr> <th>Code</th> <th>Description</th> <th>Qty</th> <th>UOM</th> </tr> </thead> <tbody> <tr> <td>GN1240A0</td> <td>COLUMN-GLA<br/>SS BLACK<br/>SILICON SEAL</td> <td>4.000</td> <td>PC</td> </tr> <tr> <td>VT1145A0</td> <td>INNER GLASS<br/>392x292x4<br/>BETFL L.</td> <td>1.000</td> <td>PC</td> </tr> </tbody> </table> | Code | Description | Qty   | UOM   | GN1240A0 | COLUMN-GLA<br>SS BLACK<br>SILICON SEAL | 4.000                                       | PC    | VT1145A0 | INNER GLASS<br>392x292x4<br>BETFL L. | 1.000                         | PC    |    |          |                                    |       |    |          |  |       |    |          |  |       |    |          |                                       |       |    |          |  |       |    |          |                            |       |    |          |                                 |       |    |          |                                  |       |    |          |                                     |       |    |          |                                      |       |    |          |  |       |    |
|           |  |  | Code       | Description                          | Qty   | UOM  |             |   |       |          |  |   |       |          |                                      |                               |       |    |          |                                    |       |    |          |  |       |    |          |  |       |    |          |                                       |       |    |          |  |       |    |          |                            |       |    |          |                                 |       |    |          |                                  |       |    |          |                                     |       |    |          |                                      |       |    |          |  |       |    |
| GN1240A0  | COLUMN-GLA<br>SS BLACK<br>SILICON SEAL               | 4.000  | PC         |                                      |   |      |             |   |       |          |  |   |       |          |                                      |                               |       |    |          |                                    |       |    |          |  |       |    |          |  |       |    |          |                                       |       |    |          |  |       |    |          |                            |       |    |          |                                 |       |    |          |                                  |       |    |          |                                     |       |    |          |                                      |       |    |          |  |       |    |
| VT1145A0  | INNER GLASS<br>392x292x4<br>BETFL L.                 | 1.000  | PC         |                                      |   |      |             |   |       |          |  |   |       |          |                                      |                               |       |    |          |                                    |       |    |          |  |       |    |          |  |       |    |          |                                       |       |    |          |  |       |    |          |                            |       |    |          |                                 |       |    |          |                                  |       |    |          |                                     |       |    |          |                                      |       |    |          |  |       |    |
| KDR1146A  | LineMicro XF003<br>COMPLETE DOOR                     | <table border="1"> <thead> <tr> <th>Code</th> <th>Description</th> <th>Qty</th> <th>UOM</th> </tr> </thead> <tbody> <tr> <td>0H3110A1</td> <td>GLASS<br/>HOLDING<br/>ST.STEEL<br/>UPPER PLATE</td> <td>2.000</td> <td>PC</td> </tr> <tr> <td>0H3111A2</td> <td>GLASS<br/>HOLDING<br/>ST.STEEL<br/>LOWER PLATE</td> <td>2.000</td> <td>PC</td> </tr> <tr> <td>0H3200B0</td> <td>HANDLE TUBE<br/>L = 388 D.18X1</td> <td>1.000</td> <td>PC</td> </tr> <tr> <td>CR1055A0</td> <td>LineMicro<br/>ROBERTA<br/>DOOR HINGE</td> <td>2.000</td> <td>PC</td> </tr> <tr> <td>GN1240A0</td> <td>COLUMN-GLA<br/>SS BLACK<br/>SILICON SEAL</td> <td>4.000</td> <td>PC</td> </tr> <tr> <td>MG1015B0</td> <td>L.MISS/L.MICR<br/>O/CHEFTOP<br/>HANDLE END</td> <td>2.000</td> <td>PC</td> </tr> <tr> <td>VI1865A0</td> <td>5X10 TCB+<br/>SELF-THREADI<br/>NG SCREW</td> <td>2.000</td> <td>PC</td> </tr> <tr> <td>VI1870A0</td> <td>50x50<br/>SELF-THREADI<br/>NG SCREW<br/>FOR PLASTIC</td> <td>2.000</td> <td>PC</td> </tr> <tr> <td>VI1875A0</td> <td>SCREW M5X10<br/>TC1/2T INOX</td> <td>6.000</td> <td>PC</td> </tr> <tr> <td>VM1370A1</td> <td>H311 LMC<br/>LEFT DOOR<br/>COLUMN</td> <td>1.000</td> <td>PC</td> </tr> <tr> <td>VM1371A1</td> <td>H311 LMC<br/>RIGHT DOOR<br/>COLUMN</td> <td>1.000</td> <td>PC</td> </tr> <tr> <td>VM1380B0</td> <td>L.MICRO<br/>GLASS-DOOR<br/>FIXING CAP</td> <td>2.000</td> <td>PC</td> </tr> <tr> <td>VT1145A0</td> <td>INNER GLASS<br/>392x292x4<br/>BETFL L.</td> <td>1.000</td> <td>PC</td> </tr> <tr> <td>VT1146A1</td> <td>LineMicro<br/>XF003<br/>EXTERNAL<br/>GLASS<br/>470x312x4</td> <td>1.000</td> <td>PC</td> </tr> </tbody> </table> | Code       | Description                          | Qty   | UOM  | 0H3110A1    | GLASS<br>HOLDING<br>ST.STEEL<br>UPPER PLATE | 2.000 | PC       | 0H3111A2                               | GLASS<br>HOLDING<br>ST.STEEL<br>LOWER PLATE | 2.000 | PC       | 0H3200B0                             | HANDLE TUBE<br>L = 388 D.18X1 | 1.000 | PC | CR1055A0 | LineMicro<br>ROBERTA<br>DOOR HINGE | 2.000 | PC | GN1240A0 | COLUMN-GLA<br>SS BLACK<br>SILICON SEAL | 4.000 | PC | MG1015B0 | L.MISS/L.MICR<br>O/CHEFTOP<br>HANDLE END | 2.000 | PC | VI1865A0 | 5X10 TCB+<br>SELF-THREADI<br>NG SCREW | 2.000 | PC | VI1870A0 | 50x50<br>SELF-THREADI<br>NG SCREW<br>FOR PLASTIC | 2.000 | PC | VI1875A0 | SCREW M5X10<br>TC1/2T INOX | 6.000 | PC | VM1370A1 | H311 LMC<br>LEFT DOOR<br>COLUMN | 1.000 | PC | VM1371A1 | H311 LMC<br>RIGHT DOOR<br>COLUMN | 1.000 | PC | VM1380B0 | L.MICRO<br>GLASS-DOOR<br>FIXING CAP | 2.000 | PC | VT1145A0 | INNER GLASS<br>392x292x4<br>BETFL L. | 1.000 | PC | VT1146A1 | LineMicro<br>XF003<br>EXTERNAL<br>GLASS<br>470x312x4 | 1.000 | PC |
| Code      | Description  | Qty  | UOM        |                                      |   |      |             |   |       |          |  |   |       |          |                                      |                               |       |    |          |                                    |       |    |          |  |       |    |          |  |       |    |          |                                       |       |    |          |  |       |    |          |                            |       |    |          |                                 |       |    |          |                                  |       |    |          |                                     |       |    |          |                                      |       |    |          |  |       |    |
| 0H3110A1  | GLASS<br>HOLDING<br>ST.STEEL<br>UPPER PLATE          | 2.000  | PC         |                                      |   |      |             |   |       |          |  |   |       |          |                                      |                               |       |    |          |                                    |       |    |          |  |       |    |          |  |       |    |          |                                       |       |    |          |  |       |    |          |                            |       |    |          |                                 |       |    |          |                                  |       |    |          |                                     |       |    |          |                                      |       |    |          |  |       |    |
| 0H3111A2  | GLASS<br>HOLDING<br>ST.STEEL<br>LOWER PLATE          | 2.000  | PC         |                                      |   |      |             |   |       |          |  |   |       |          |                                      |                               |       |    |          |                                    |       |    |          |  |       |    |          |  |       |    |          |                                       |       |    |          |  |       |    |          |                            |       |    |          |                                 |       |    |          |                                  |       |    |          |                                     |       |    |          |                                      |       |    |          |  |       |    |
| 0H3200B0  | HANDLE TUBE<br>L = 388 D.18X1                        | 1.000  | PC         |                                      |   |      |             |   |       |          |  |   |       |          |                                      |                               |       |    |          |                                    |       |    |          |  |       |    |          |  |       |    |          |                                       |       |    |          |  |       |    |          |                            |       |    |          |                                 |       |    |          |                                  |       |    |          |                                     |       |    |          |                                      |       |    |          |  |       |    |
| CR1055A0  | LineMicro<br>ROBERTA<br>DOOR HINGE                   | 2.000  | PC         |                                      |   |      |             |   |       |          |  |   |       |          |                                      |                               |       |    |          |                                    |       |    |          |  |       |    |          |  |       |    |          |                                       |       |    |          |  |       |    |          |                            |       |    |          |                                 |       |    |          |                                  |       |    |          |                                     |       |    |          |                                      |       |    |          |  |       |    |
| GN1240A0  | COLUMN-GLA<br>SS BLACK<br>SILICON SEAL               | 4.000  | PC         |                                      |   |      |             |   |       |          |  |   |       |          |                                      |                               |       |    |          |                                    |       |    |          |  |       |    |          |  |       |    |          |                                       |       |    |          |  |       |    |          |                            |       |    |          |                                 |       |    |          |                                  |       |    |          |                                     |       |    |          |                                      |       |    |          |  |       |    |
| MG1015B0  | L.MISS/L.MICR<br>O/CHEFTOP<br>HANDLE END             | 2.000  | PC         |                                      |   |      |             |   |       |          |  |   |       |          |                                      |                               |       |    |          |                                    |       |    |          |  |       |    |          |  |       |    |          |                                       |       |    |          |  |       |    |          |                            |       |    |          |                                 |       |    |          |                                  |       |    |          |                                     |       |    |          |                                      |       |    |          |  |       |    |
| VI1865A0  | 5X10 TCB+<br>SELF-THREADI<br>NG SCREW                | 2.000  | PC         |                                      |   |      |             |   |       |          |  |   |       |          |                                      |                               |       |    |          |                                    |       |    |          |  |       |    |          |  |       |    |          |                                       |       |    |          |  |       |    |          |                            |       |    |          |                                 |       |    |          |                                  |       |    |          |                                     |       |    |          |                                      |       |    |          |  |       |    |
| VI1870A0  | 50x50<br>SELF-THREADI<br>NG SCREW<br>FOR PLASTIC     | 2.000  | PC         |                                      |   |      |             |   |       |          |  |   |       |          |                                      |                               |       |    |          |                                    |       |    |          |  |       |    |          |  |       |    |          |                                       |       |    |          |  |       |    |          |                            |       |    |          |                                 |       |    |          |                                  |       |    |          |                                     |       |    |          |                                      |       |    |          |  |       |    |
| VI1875A0  | SCREW M5X10<br>TC1/2T INOX                           | 6.000  | PC         |                                      |   |      |             |   |       |          |  |   |       |          |                                      |                               |       |    |          |                                    |       |    |          |  |       |    |          |  |       |    |          |                                       |       |    |          |  |       |    |          |                            |       |    |          |                                 |       |    |          |                                  |       |    |          |                                     |       |    |          |                                      |       |    |          |  |       |    |
| VM1370A1  | H311 LMC<br>LEFT DOOR<br>COLUMN                      | 1.000  | PC         |                                      |   |      |             |   |       |          |  |   |       |          |                                      |                               |       |    |          |                                    |       |    |          |  |       |    |          |  |       |    |          |                                       |       |    |          |  |       |    |          |                            |       |    |          |                                 |       |    |          |                                  |       |    |          |                                     |       |    |          |                                      |       |    |          |  |       |    |
| VM1371A1  | H311 LMC<br>RIGHT DOOR<br>COLUMN                     | 1.000  | PC         |                                      |   |      |             |   |       |          |  |   |       |          |                                      |                               |       |    |          |                                    |       |    |          |  |       |    |          |  |       |    |          |                                       |       |    |          |  |       |    |          |                            |       |    |          |                                 |       |    |          |                                  |       |    |          |                                     |       |    |          |                                      |       |    |          |  |       |    |
| VM1380B0  | L.MICRO<br>GLASS-DOOR<br>FIXING CAP                  | 2.000  | PC         |                                      |   |      |             |   |       |          |  |   |       |          |                                      |                               |       |    |          |                                    |       |    |          |  |       |    |          |  |       |    |          |                                       |       |    |          |  |       |    |          |                            |       |    |          |                                 |       |    |          |                                  |       |    |          |                                     |       |    |          |                                      |       |    |          |  |       |    |
| VT1145A0  | INNER GLASS<br>392x292x4<br>BETFL L.                 | 1.000  | PC         |                                      |   |      |             |   |       |          |  |   |       |          |                                      |                               |       |    |          |                                    |       |    |          |  |       |    |          |  |       |    |          |                                       |       |    |          |  |       |    |          |                            |       |    |          |                                 |       |    |          |                                  |       |    |          |                                     |       |    |          |                                      |       |    |          |  |       |    |
| VT1146A1  | LineMicro<br>XF003<br>EXTERNAL<br>GLASS<br>470x312x4 | 1.000  | PC         |                                      |   |      |             |   |       |          |  |   |       |          |                                      |                               |       |    |          |                                    |       |    |          |  |       |    |          |  |       |    |          |                                       |       |    |          |  |       |    |          |                            |       |    |          |                                 |       |    |          |                                  |       |    |          |                                     |       |    |          |                                      |       |    |          |  |       |    |



| COMPONENT |  |  | SPARE PART |  |   |      |             |   |       |          |  |   |       |    |          |                               |       |    |          |                                    |       |    |          |  |       |    |          |  |       |    |          |                                       |       |    |          |  |       |    |          |                            |       |    |          |                                 |       |    |          |                                  |       |    |          |                                     |       |    |          |                                      |       |    |          |  |       |    |
|-----------|--|--|------------|--|---|------|-------------|---|-------|----------|--|---|-------|----|----------|-------------------------------|-------|----|----------|------------------------------------|-------|----|----------|--|-------|----|----------|--|-------|----|----------|---------------------------------------|-------|----|----------|--|-------|----|----------|----------------------------|-------|----|----------|---------------------------------|-------|----|----------|----------------------------------|-------|----|----------|-------------------------------------|-------|----|----------|--------------------------------------|-------|----|----------|--|-------|----|
| Code      | Description  | Image  | Code       | Description                              | Kit components  |      |             |   |       |          |  |   |       |    |          |                               |       |    |          |                                    |       |    |          |  |       |    |          |  |       |    |          |                                       |       |    |          |  |       |    |          |                            |       |    |          |                                 |       |    |          |                                  |       |    |          |                                     |       |    |          |                                      |       |    |          |  |       |    |
| VT1146A   | LineMicro XF003<br>EXTERNAL GLASS<br>470x312x4       |   | KVT1146A   | LINEMICRO XF003<br>EXTERNAL GLASS<br>KIT | <table border="1"> <thead> <tr> <th>Code</th> <th>Description</th> <th>Qty</th> <th>UOM</th> </tr> </thead> <tbody> <tr> <td>VT1146A1</td> <td>LineMicro<br/>XF003<br/>EXTERNAL<br/>GLASS<br/>470x312x4</td> <td>1.000</td> <td>PC</td> </tr> </tbody> </table> | Code | Description | Qty   | UOM   | VT1146A1 | LineMicro<br>XF003<br>EXTERNAL<br>GLASS<br>470x312x4 | 1.000                                       | PC    |    |          |                               |       |    |          |                                    |       |    |          |  |       |    |          |  |       |    |          |                                       |       |    |          |  |       |    |          |                            |       |    |          |                                 |       |    |          |                                  |       |    |          |                                     |       |    |          |                                      |       |    |          |  |       |    |
|           |  |  | Code       | Description                              | Qty   | UOM  |             |   |       |          |  |   |       |    |          |                               |       |    |          |                                    |       |    |          |  |       |    |          |  |       |    |          |                                       |       |    |          |  |       |    |          |                            |       |    |          |                                 |       |    |          |                                  |       |    |          |                                     |       |    |          |                                      |       |    |          |  |       |    |
| VT1146A1  | LineMicro<br>XF003<br>EXTERNAL<br>GLASS<br>470x312x4 | 1.000  | PC         |  |   |      |             |   |       |          |  |   |       |    |          |                               |       |    |          |                                    |       |    |          |  |       |    |          |  |       |    |          |                                       |       |    |          |  |       |    |          |                            |       |    |          |                                 |       |    |          |                                  |       |    |          |                                     |       |    |          |                                      |       |    |          |  |       |    |
| KDR1146A  | LineMicro XF003<br>COMPLETE DOOR                     | <table border="1"> <thead> <tr> <th>Code</th> <th>Description</th> <th>Qty</th> <th>UOM</th> </tr> </thead> <tbody> <tr> <td>0H3110A1</td> <td>GLASS<br/>HOLDING<br/>ST.STEEL<br/>UPPER PLATE</td> <td>2.000</td> <td>PC</td> </tr> <tr> <td>0H3111A2</td> <td>GLASS<br/>HOLDING<br/>ST.STEEL<br/>LOWER PLATE</td> <td>2.000</td> <td>PC</td> </tr> <tr> <td>0H3200B0</td> <td>HANDLE TUBE<br/>L = 388 D.18X1</td> <td>1.000</td> <td>PC</td> </tr> <tr> <td>CR1055A0</td> <td>LineMicro<br/>ROBERTA<br/>DOOR HINGE</td> <td>2.000</td> <td>PC</td> </tr> <tr> <td>GN1240A0</td> <td>COLUMN-GLA<br/>SS BLACK<br/>SILICON SEAL</td> <td>4.000</td> <td>PC</td> </tr> <tr> <td>MG1015B0</td> <td>L.MISS/L.MICR<br/>O/CHEFTOP<br/>HANDLE END</td> <td>2.000</td> <td>PC</td> </tr> <tr> <td>VI1865A0</td> <td>5X10 TCB+<br/>SELF-THREADI<br/>NG SCREW</td> <td>2.000</td> <td>PC</td> </tr> <tr> <td>VI1870A0</td> <td>50x50<br/>SELF-THREADI<br/>NG SCREW<br/>FOR PLASTIC</td> <td>2.000</td> <td>PC</td> </tr> <tr> <td>VI1875A0</td> <td>SCREW M5X10<br/>TC1/2T INOX</td> <td>6.000</td> <td>PC</td> </tr> <tr> <td>VM1370A1</td> <td>H311 LMC<br/>LEFT DOOR<br/>COLUMN</td> <td>1.000</td> <td>PC</td> </tr> <tr> <td>VM1371A1</td> <td>H311 LMC<br/>RIGHT DOOR<br/>COLUMN</td> <td>1.000</td> <td>PC</td> </tr> <tr> <td>VM1380B0</td> <td>L.MICRO<br/>GLASS-DOOR<br/>FIXING CAP</td> <td>2.000</td> <td>PC</td> </tr> <tr> <td>VT1145A0</td> <td>INNER GLASS<br/>392x292x4<br/>BETFL L.</td> <td>1.000</td> <td>PC</td> </tr> <tr> <td>VT1146A1</td> <td>LineMicro<br/>XF003<br/>EXTERNAL<br/>GLASS<br/>470x312x4</td> <td>1.000</td> <td>PC</td> </tr> </tbody> </table> | Code       | Description                              | Qty   | UOM  | 0H3110A1    | GLASS<br>HOLDING<br>ST.STEEL<br>UPPER PLATE | 2.000 | PC       | 0H3111A2   | GLASS<br>HOLDING<br>ST.STEEL<br>LOWER PLATE | 2.000 | PC | 0H3200B0 | HANDLE TUBE<br>L = 388 D.18X1 | 1.000 | PC | CR1055A0 | LineMicro<br>ROBERTA<br>DOOR HINGE | 2.000 | PC | GN1240A0 | COLUMN-GLA<br>SS BLACK<br>SILICON SEAL | 4.000 | PC | MG1015B0 | L.MISS/L.MICR<br>O/CHEFTOP<br>HANDLE END | 2.000 | PC | VI1865A0 | 5X10 TCB+<br>SELF-THREADI<br>NG SCREW | 2.000 | PC | VI1870A0 | 50x50<br>SELF-THREADI<br>NG SCREW<br>FOR PLASTIC | 2.000 | PC | VI1875A0 | SCREW M5X10<br>TC1/2T INOX | 6.000 | PC | VM1370A1 | H311 LMC<br>LEFT DOOR<br>COLUMN | 1.000 | PC | VM1371A1 | H311 LMC<br>RIGHT DOOR<br>COLUMN | 1.000 | PC | VM1380B0 | L.MICRO<br>GLASS-DOOR<br>FIXING CAP | 2.000 | PC | VT1145A0 | INNER GLASS<br>392x292x4<br>BETFL L. | 1.000 | PC | VT1146A1 | LineMicro<br>XF003<br>EXTERNAL<br>GLASS<br>470x312x4 | 1.000 | PC |
| Code      | Description  | Qty  | UOM        |  |   |      |             |   |       |          |  |   |       |    |          |                               |       |    |          |                                    |       |    |          |  |       |    |          |  |       |    |          |                                       |       |    |          |  |       |    |          |                            |       |    |          |                                 |       |    |          |                                  |       |    |          |                                     |       |    |          |                                      |       |    |          |  |       |    |
| 0H3110A1  | GLASS<br>HOLDING<br>ST.STEEL<br>UPPER PLATE          | 2.000  | PC         |  |   |      |             |   |       |          |  |   |       |    |          |                               |       |    |          |                                    |       |    |          |  |       |    |          |  |       |    |          |                                       |       |    |          |  |       |    |          |                            |       |    |          |                                 |       |    |          |                                  |       |    |          |                                     |       |    |          |                                      |       |    |          |  |       |    |
| 0H3111A2  | GLASS<br>HOLDING<br>ST.STEEL<br>LOWER PLATE          | 2.000  | PC         |  |   |      |             |   |       |          |  |   |       |    |          |                               |       |    |          |                                    |       |    |          |  |       |    |          |  |       |    |          |                                       |       |    |          |  |       |    |          |                            |       |    |          |                                 |       |    |          |                                  |       |    |          |                                     |       |    |          |                                      |       |    |          |  |       |    |
| 0H3200B0  | HANDLE TUBE<br>L = 388 D.18X1                        | 1.000  | PC         |  |   |      |             |   |       |          |  |   |       |    |          |                               |       |    |          |                                    |       |    |          |  |       |    |          |  |       |    |          |                                       |       |    |          |  |       |    |          |                            |       |    |          |                                 |       |    |          |                                  |       |    |          |                                     |       |    |          |                                      |       |    |          |  |       |    |
| CR1055A0  | LineMicro<br>ROBERTA<br>DOOR HINGE                   | 2.000  | PC         |  |   |      |             |   |       |          |  |   |       |    |          |                               |       |    |          |                                    |       |    |          |  |       |    |          |  |       |    |          |                                       |       |    |          |  |       |    |          |                            |       |    |          |                                 |       |    |          |                                  |       |    |          |                                     |       |    |          |                                      |       |    |          |  |       |    |
| GN1240A0  | COLUMN-GLA<br>SS BLACK<br>SILICON SEAL               | 4.000  | PC         |  |   |      |             |   |       |          |  |   |       |    |          |                               |       |    |          |                                    |       |    |          |  |       |    |          |  |       |    |          |                                       |       |    |          |  |       |    |          |                            |       |    |          |                                 |       |    |          |                                  |       |    |          |                                     |       |    |          |                                      |       |    |          |  |       |    |
| MG1015B0  | L.MISS/L.MICR<br>O/CHEFTOP<br>HANDLE END             | 2.000  | PC         |  |   |      |             |   |       |          |  |   |       |    |          |                               |       |    |          |                                    |       |    |          |  |       |    |          |  |       |    |          |                                       |       |    |          |  |       |    |          |                            |       |    |          |                                 |       |    |          |                                  |       |    |          |                                     |       |    |          |                                      |       |    |          |  |       |    |
| VI1865A0  | 5X10 TCB+<br>SELF-THREADI<br>NG SCREW                | 2.000  | PC         |  |   |      |             |   |       |          |  |   |       |    |          |                               |       |    |          |                                    |       |    |          |  |       |    |          |  |       |    |          |                                       |       |    |          |  |       |    |          |                            |       |    |          |                                 |       |    |          |                                  |       |    |          |                                     |       |    |          |                                      |       |    |          |  |       |    |
| VI1870A0  | 50x50<br>SELF-THREADI<br>NG SCREW<br>FOR PLASTIC     | 2.000  | PC         |  |   |      |             |   |       |          |  |   |       |    |          |                               |       |    |          |                                    |       |    |          |  |       |    |          |  |       |    |          |                                       |       |    |          |  |       |    |          |                            |       |    |          |                                 |       |    |          |                                  |       |    |          |                                     |       |    |          |                                      |       |    |          |  |       |    |
| VI1875A0  | SCREW M5X10<br>TC1/2T INOX                           | 6.000  | PC         |  |   |      |             |   |       |          |  |   |       |    |          |                               |       |    |          |                                    |       |    |          |  |       |    |          |  |       |    |          |                                       |       |    |          |  |       |    |          |                            |       |    |          |                                 |       |    |          |                                  |       |    |          |                                     |       |    |          |                                      |       |    |          |  |       |    |
| VM1370A1  | H311 LMC<br>LEFT DOOR<br>COLUMN                      | 1.000  | PC         |  |   |      |             |   |       |          |  |   |       |    |          |                               |       |    |          |                                    |       |    |          |  |       |    |          |  |       |    |          |                                       |       |    |          |  |       |    |          |                            |       |    |          |                                 |       |    |          |                                  |       |    |          |                                     |       |    |          |                                      |       |    |          |  |       |    |
| VM1371A1  | H311 LMC<br>RIGHT DOOR<br>COLUMN                     | 1.000  | PC         |  |   |      |             |   |       |          |  |   |       |    |          |                               |       |    |          |                                    |       |    |          |  |       |    |          |  |       |    |          |                                       |       |    |          |  |       |    |          |                            |       |    |          |                                 |       |    |          |                                  |       |    |          |                                     |       |    |          |                                      |       |    |          |  |       |    |
| VM1380B0  | L.MICRO<br>GLASS-DOOR<br>FIXING CAP                  | 2.000  | PC         |  |   |      |             |   |       |          |  |   |       |    |          |                               |       |    |          |                                    |       |    |          |  |       |    |          |  |       |    |          |                                       |       |    |          |  |       |    |          |                            |       |    |          |                                 |       |    |          |                                  |       |    |          |                                     |       |    |          |                                      |       |    |          |  |       |    |
| VT1145A0  | INNER GLASS<br>392x292x4<br>BETFL L.                 | 1.000  | PC         |  |   |      |             |   |       |          |  |   |       |    |          |                               |       |    |          |                                    |       |    |          |  |       |    |          |  |       |    |          |                                       |       |    |          |  |       |    |          |                            |       |    |          |                                 |       |    |          |                                  |       |    |          |                                     |       |    |          |                                      |       |    |          |  |       |    |
| VT1146A1  | LineMicro<br>XF003<br>EXTERNAL<br>GLASS<br>470x312x4 | 1.000  | PC         |  |   |      |             |   |       |          |  |   |       |    |          |                               |       |    |          |                                    |       |    |          |  |       |    |          |  |       |    |          |                                       |       |    |          |  |       |    |          |                            |       |    |          |                                 |       |    |          |                                  |       |    |          |                                     |       |    |          |                                      |       |    |          |  |       |    |