

1 2 3 4 5 6

A

B

C

D

E

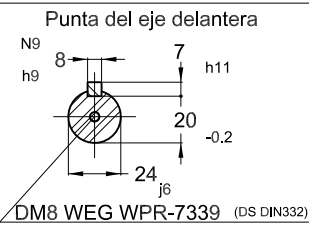
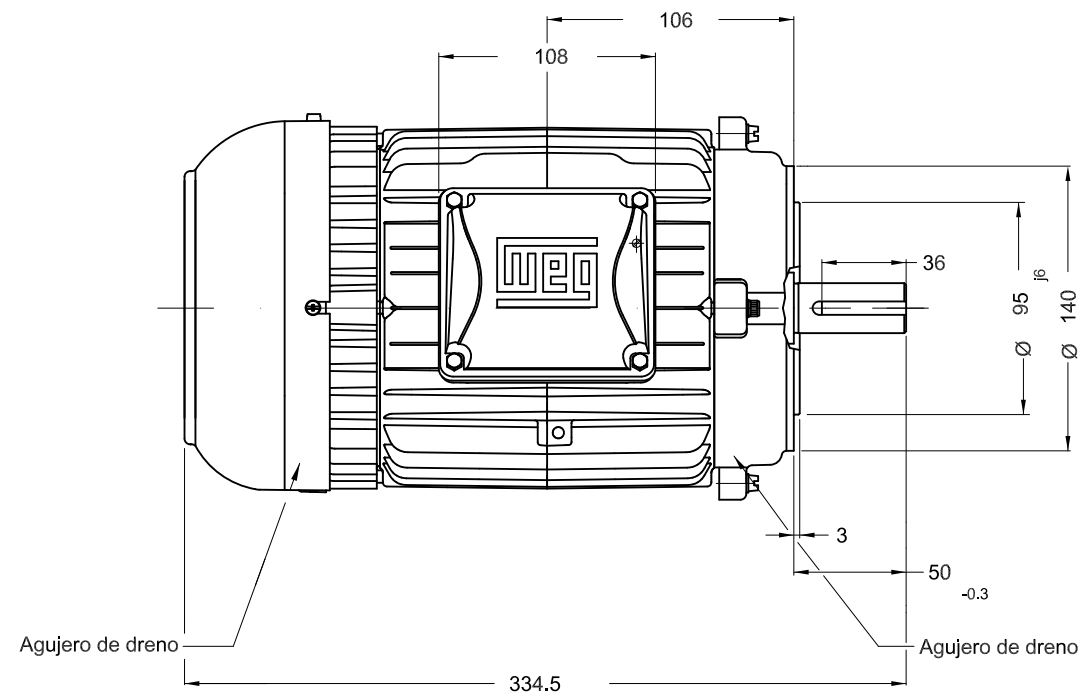
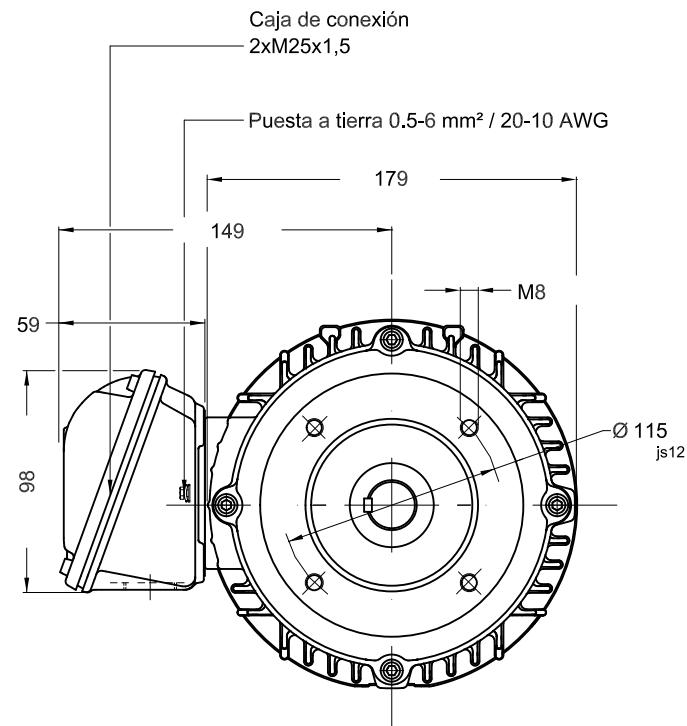

Color RAL 6002  
Plan de pintura 207A  
Forma constructiva B14L(D)

1.1 kW (1.5 HP) 04 Polos 60 Hz A

No MODIFICACION	LOC	RESUMEN DE MODIFICACIONES	EJECUTADO	VERIFICADO	LIBERADO	FECHA	VER
EJEC.	HYBRISUSER	MOTOR TRIF. W22 IE3					
VERIF.		CARCASA L90S IP55 TEFC					
LIBER.							
FECHA LB.	WMO	Jaragua do Sul	Ingeniera del Producto	HOJA	1 / 1		

PREVIEW  
WDD

