

EJE	
ESTÁNDAR	X
OPCIONAL	
ESPECIAL	

Dimensões em mm  
Dimensiones en mm

ESTA REVISION SUBSTITUYE Y ANULA LA EMISION ANTERIOR, LA CUAL DEBERA SER ELIMINADA.

A

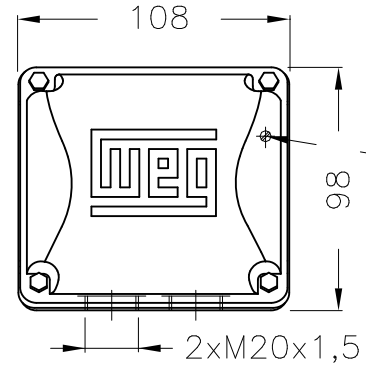

Puesta a tierra 0.5-6 mm<sup>2</sup> / 20-10 AWG

Caja de conexión

B

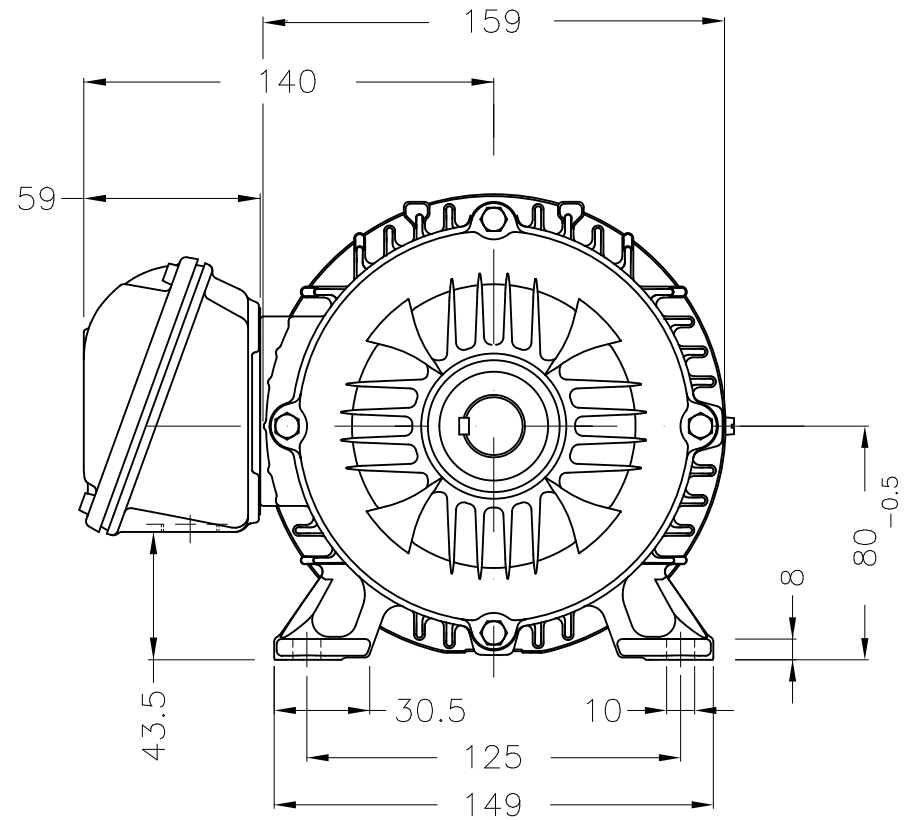

C

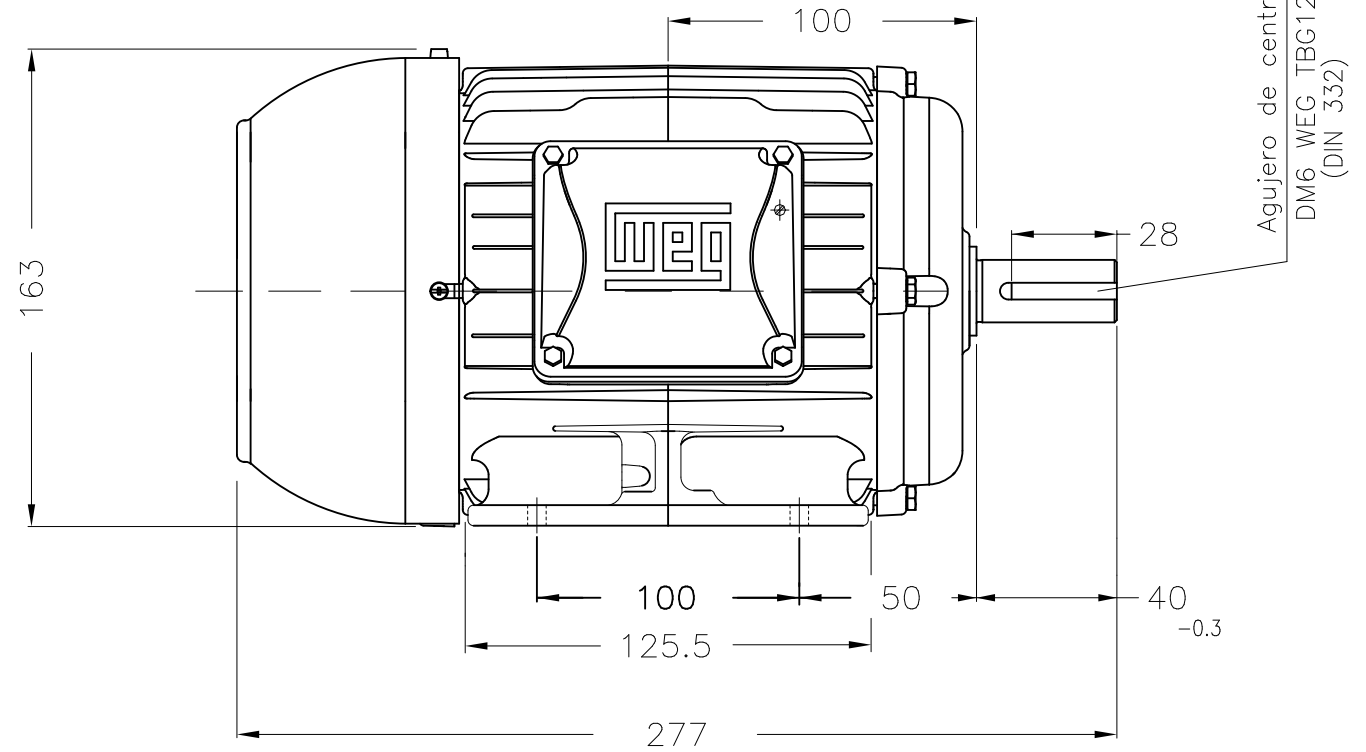

Agujero de centro  
DM6 WEG TBC12  
(DIN 332)

D

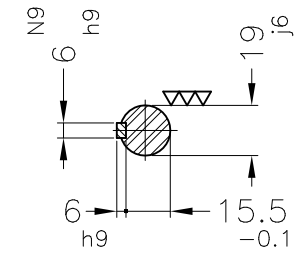

Punta del eje delantera

E

Color RAL 5009  
Plan de pintura 207A  
Factor de servicio 1.15  
Forma constructiva B3L(D)

No MODIFICACION ECM	LOC LOC	RESUMEN DE MODIFICACIONES SUMMARY OF MODIFICATIONS	EJECUTADO EXECUTED	VERIFICADO CHECKED	LIBERADO RELEASED	FECHA DATE	VER VER
EJEC. /EXECUTED	USERADMIN	MOTOR TRIFASICO W22 - PLUS CARCASA 80 IP55 TEFC Código WEG: 11571231					
VERIF. /CHECKED							
LIBER. /RELEASED							
FECHA LÍB/REL DT	30.03.2019	WMO	Jaragua do Sul	Ingeniera del Producto	HOJA/SHEET	1 / 1	

1,5 kW (2 HP) 02 Polos 60Hz

